

Models:

DM6036, DM6036-S

DM8042, DM8042-S

Glass Doors



These bi-fold glass doors have been tested for use with specific Hearth & Home Technologies products. Check with your local building code agency before you begin installation to ensure compliance with local codes, including the need for permits and follow-up inspections. If you encounter any problems regarding code approvals, or if you need clarification of any of the instructions contained here, contact your Hearth & Home Technologies dealer. For the dealer nearest you, please visit www.hearthnhome.com.

Note: An arrow (➡) found in the text signifies change in content.

CAUTION! Risk of Cuts/Abrasions. Wear protective gloves and safety glasses during installation. Sheet metal edges are sharp.



WARNING



HOT SURFACES!

Screen/mesh, glass doors and other surfaces are hot during operation AND cool down.

Hot screen/mesh and glass doors will cause burns.

- Do not touch screen/mesh or glass doors until cooled
- NEVER allow children to touch screen/mesh or glass doors
- Keep children away
- CAREFULLY SUPERVISE children in same room as fireplace.
- Alert children and adults to hazards of high temperatures.

High temperatures may ignite clothing or other flammable materials.

- Keep clothing, furniture, draperies and other flammable materials away.



Figure 1 - Install the Door Track

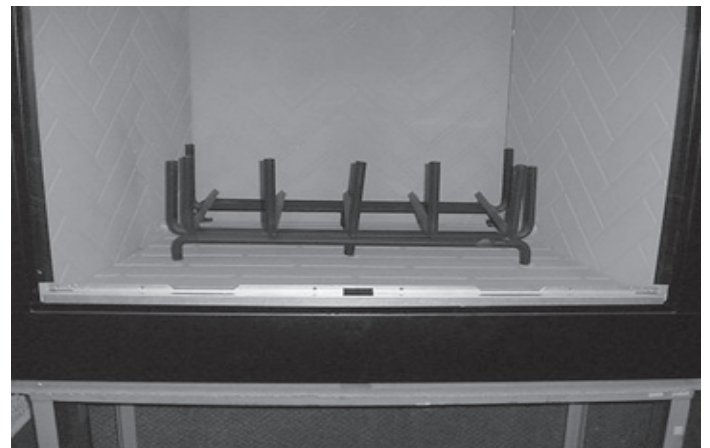

Figure 2 - Installed Door Track

- Starting with the left side going in first, slip the bottom door track along the front edge of the hearth refractory and line it up end to end. See Figures 1-2.
- Install the top door track behind the front face. Secure the track in place with one screw from fastener pack, in the center.
- On each end of the top door track, add a spring clip to each end and secure with 2 screws each (they are also adjustment screws), also from fastener pack See Figure 3.

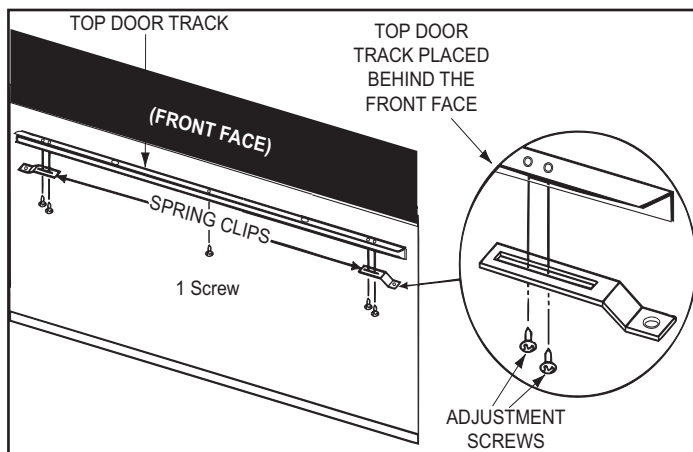

Figure 3 - Spring Clip Placement

- Install the Side Fillers
 - a. Push the screens to the center of the fireplace opening.
 - b. Slip the side filler in front of the side refractory with the notch to the bottom and the tabs to the front. See Figure 4.

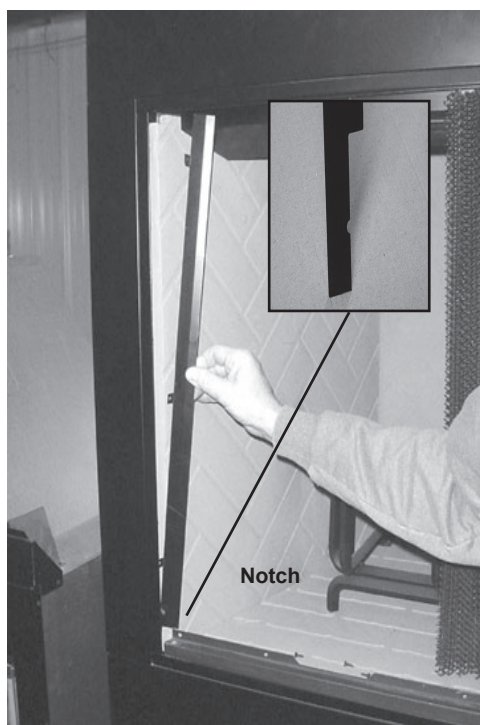

Figure 4 - Slide the Side Filler In

- c. Fasten the side filler to the corresponding holes in the column with the screws provided in 2nd fastener pack.

Note: If there are no holes in the side column, use the side filler as a template and drill holes in the column. Fasten filler to column.



Figure 5 - Fastening the Side Filler

- d. Repeat for the other side.
- Fold up one door (handles at the bottom) and set the bottom pin into the hole in the bottom door track. See Figure 6.

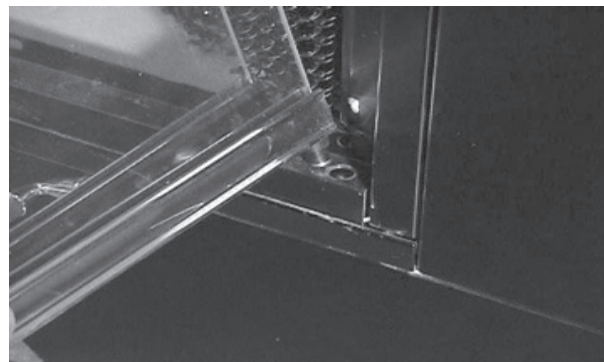

Figure 6 - Bottom Pin/Door Track

- Slide the top pins on the door into the top door track. Slide the door over until the pivot pin snaps into the spring clip. See Figure 7.

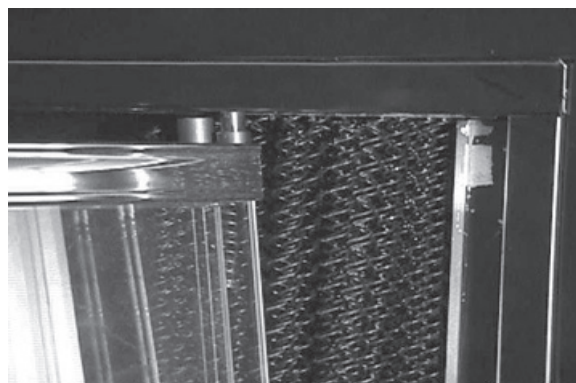

Figure 7 - Pivot Pins/Top Door Track

- Repeat Steps 6-7 for the other side.
- To adjust the door alignment, loosen the screws at the top spring clip, sliding doors in or out, then tightening the screws.