

Log Sets:

**DUZY2LS-18-24, DUZY2LS-30,
DUZY3LS-18-24, DUZY3LS-30,
DUZY5LS-18-24, DUZY5LS-30**

GAS-FIRED



Log Set	Used on Duzy Model
DUZY2LS-18-24	RB-18-24NI RB-18-24PI
DUZY3LS-18-24	
DUZY5LS-18-24	
DUZY2LS-30	RB-30NI RB-30PI
DUZY3LS-30	
DUZY5LS-30	

INSTALLER:

Leave this manual with party responsible for use and operation.

OWNER:

Retain this manual for future reference.

⚠ WARNING! The positioning of the logs is critical to the safe and clean operation of this appliance. Sooting and/or other problems may result if the logs are not properly and firmly positioned on the appliance. Never add additional logs or embellishments not provided with the appliance, such as pine cones or vermiculite.

Failure to position the parts in accordance with the diagrams below or using parts not specifically approved for this appliance may result in property damage or personal injury.

⚠ WARNING! This part is designed to be used with a product that operates with one of the following fuel sources: liquid propane, natural gas, wood, or wood pellets. This product and the fuel used to operate this product, and the products of combustion of such fuel, can expose you to chemicals including benzene and carbon black, which are known to the State of California to cause cancer, and carbon monoxide which is known to the State of California to cause birth defects and other reproductive harm. For more information go to: www.P65Warnings.ca.gov. For a complete list of warnings and safety instructions for this product, download the Owner's Manual at www.hearthnhome.com.

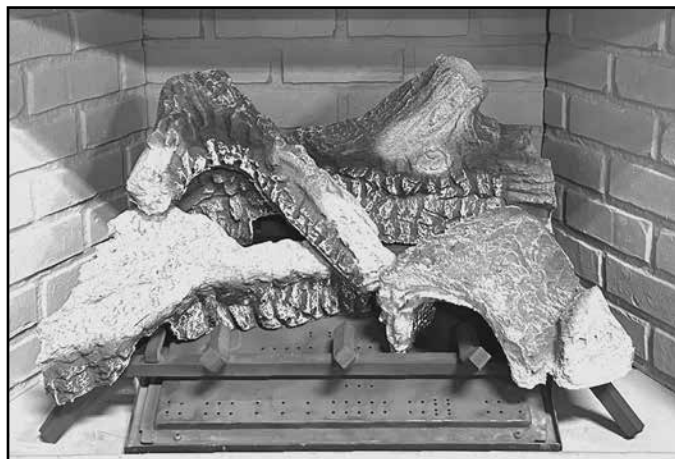

DUZY2LS-18-24 & DUZY2LS-30

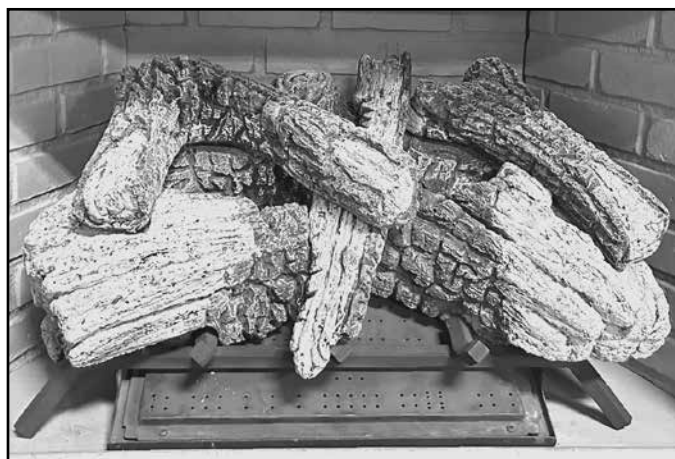

DUZY3LS-18-24 & DUZY3LS-30



DUZY5LS-18-24 & DUZY5LS-30

DUZY2LS-18-24

IMPORTANT: Remove logs, handling carefully by holding gently at each end. Gloves are recommended to prevent skin irritation from ceramic fibers. If skin becomes irritated, wash gently with soap and water.

Item	Description	Qty.
1	Rear Log	1
2	Right Log	1
3	Left Log	1
4	Top Log	1

1. Install Rear Log #1 on the (2) locating pins on either side of the grate. See Figure 1. Visually verify the log is securely placed on the pins and in contact with the grate. See Figure 2.

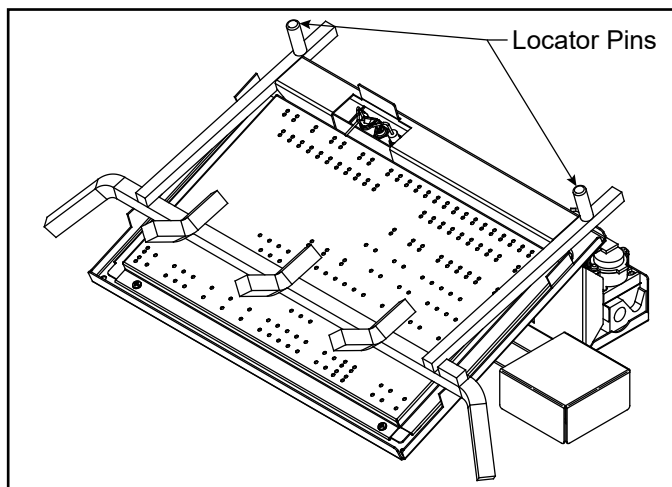

Figure 1 Locator Pins



Figure 2 Rear Log #1

2. Install Right Log #2 on the right front side of the grate. Slide the log to the rear until touching the Rear Log #1. Visually verify the log is resting on the grate. See Figure 3.



Figure 3 Right Log #2

3. Install the Left Log #3 with its bottom groove resting on the left side of the grate. Slide the log back until touching Rear Log #1. Visually check to verify the log is resting on the grate. See Figure 4.

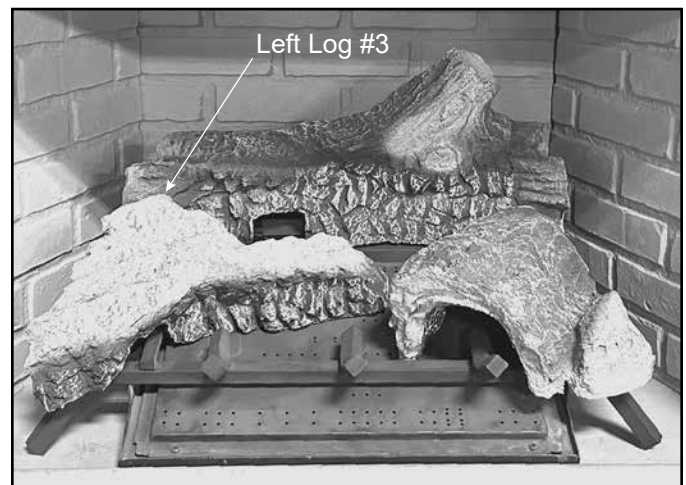

Figure 4 Left Log #3

4. Install Top Log #4 with the base sitting on Rear Log #1 and Left Log #3. Visually check to verify Top Log #4 the log is resting on Rear Log #1 and Left Log #3. See Figure 5.

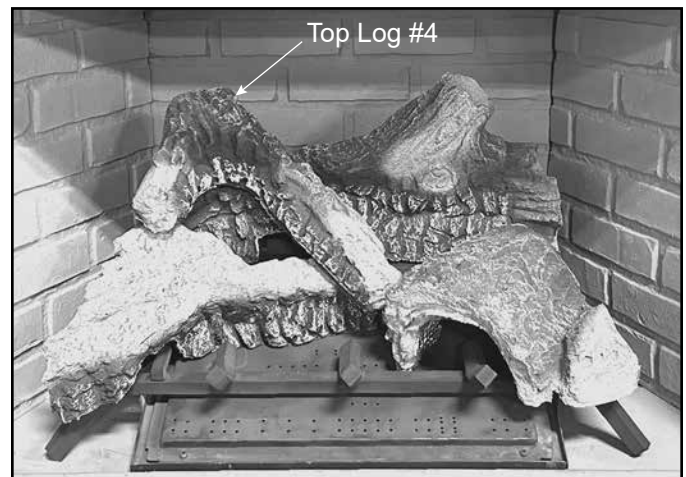

Figure 5 Top Log #4

DUZY2LS-30

IMPORTANT: Remove logs, handling carefully by holding gently at each end. Gloves are recommended to prevent skin irritation from ceramic fibers. If skin becomes irritated, wash gently with soap and water.

Item	Description	Qty.
1	Rear Log	1
2	Right Log	1
3	Left Log	1
4	Top Log	1

1. Install Rear Log #1 on the (2) locating pins on either side of the grate. See Figure 1. Visually verify the log is securely placed on the pins and in contact with the grate. See Figure 2.

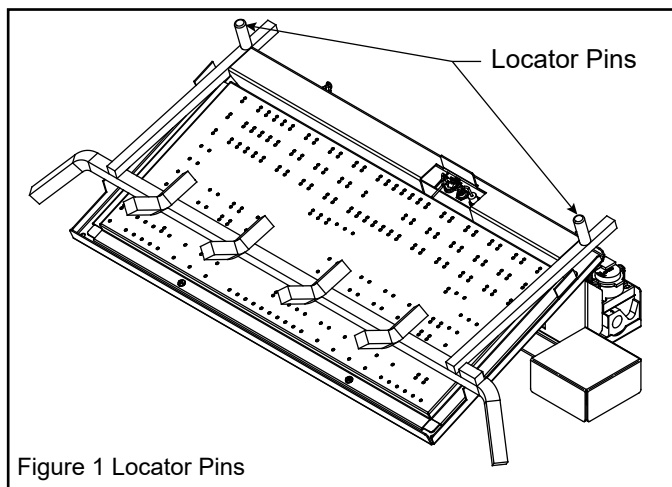

Figure 1 Locator Pins

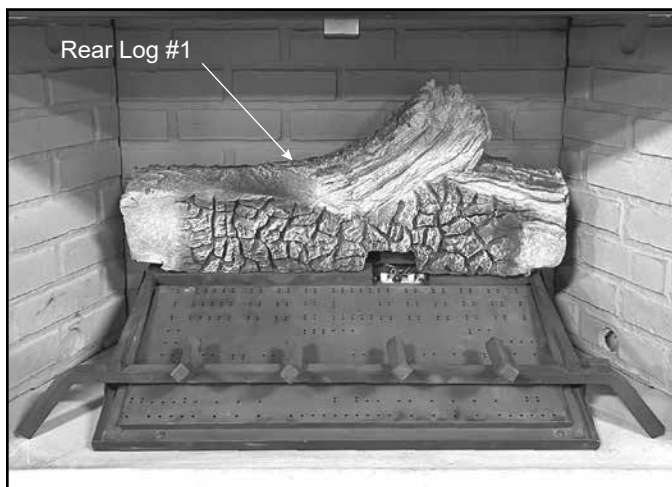

Figure 2 Rear Log #1

2. Install Right Log #2 on the right front side of the grate. Slide the log to the rear until touching the Rear Log #1. Visually verify the log is resting on the grate. See Figure 3

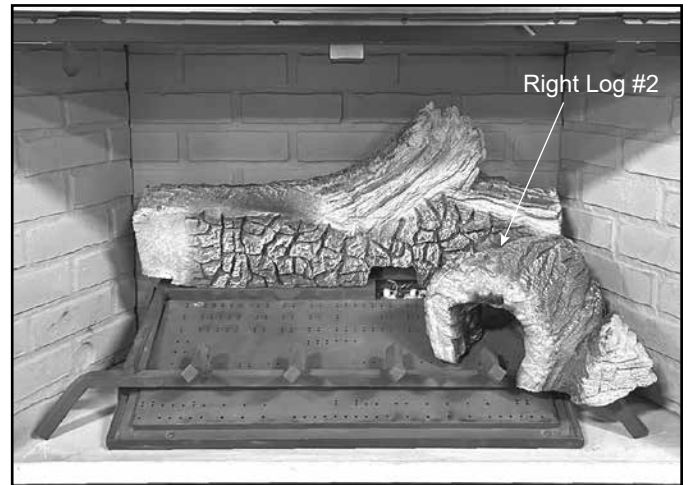

Figure 3 Right Log #2

3. Install the Left Log #3 with its bottom groove resting on the right side of the grate bar. Slide the log back until touching Rear Log #1. Visually check to verify the log is resting on the grate. See Figure 4.

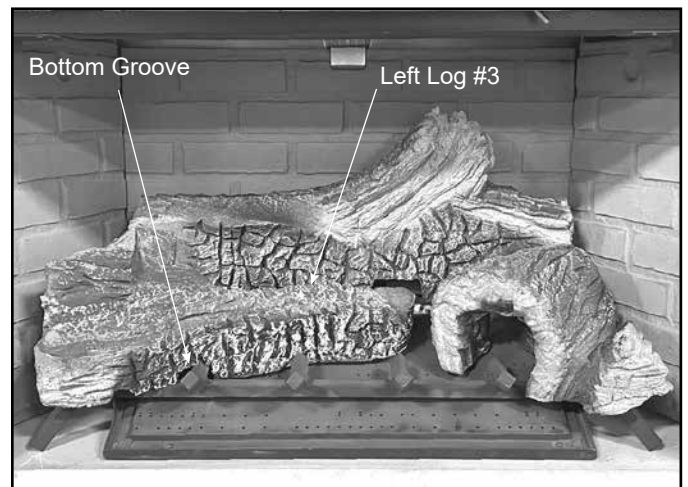

Figure 4 Left Log #3

4. Install Top Log #4 with the base sitting on Rear Log #1 and Left Log #3. Visually check to verify Top Log #4 the log is resting on Rear Log #1 and Left Log #3. See Figure 5.



Figure 5 Top Log #4

DUZY3LS-18-24

IMPORTANT: Remove logs, handling carefully by holding gently at each end. Gloves are recommended to prevent skin irritation from ceramic fibers. If skin becomes irritated, wash gently with soap and water.

Item	Description	Qty.
1	Rear Log	1
2	Front Left Log	1
3	Front Right Log	1
4	Top Middle Log	1
5	Top Right Log	1
6	Top Left Log	1

1. Install Rear Log #1 on the (2) locating pins on either side of the grate. See Figure 1. Visually verify the log is securely placed on the pins and in contact with the grate. See Figure 2.

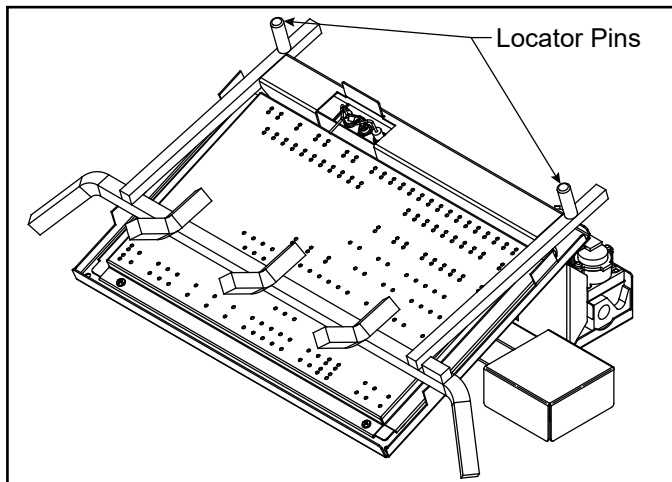

Figure 1 Locator Pins



Figure 2 Rear Log #1

2. Place Front Left Log #2 on left front of grate bar aligning cutout in bottom of log with grate bar. See Figure 3.

3. Place Front Right Log #3 on the right front of grate bar, aligning cutout in bottom of log with grate bar. Make sure Front Log #3 touches Rear Log #1. See Figure 3.

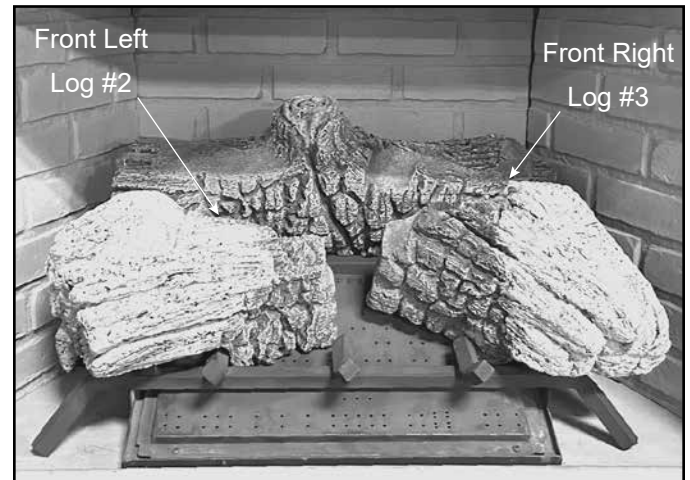

Figure 3 Front Left Log #2 & Front Right Log #3

4. Place Top Middle Log #4 on Rear Log #1. Locate the middle log against the raised area of rear log and align notch in front end with grate bar. See Figure 4.



Figure 4 Top Middle Log #4

5. Rest Top Right Log #5 on Front Right Log #3.
6. Align Top Left Log #6 with notches on Front Left Log #2 and Top Middle Log #4. See Figure 5.

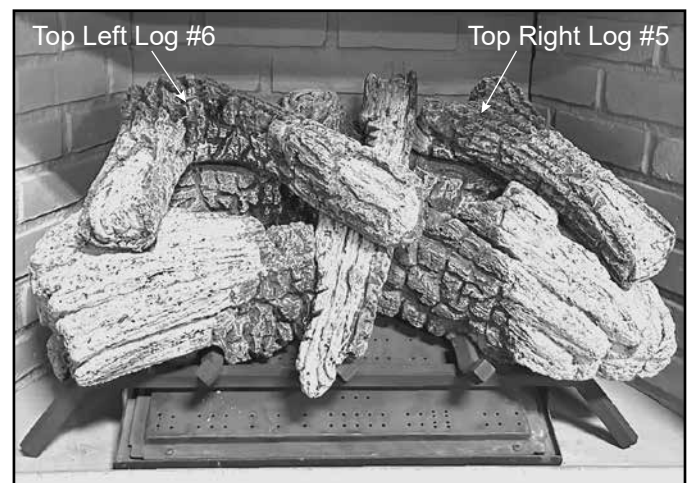

Figure 5 Top Right Log #5 & Top Left Log #6

DUZY3LS-30

IMPORTANT: Remove logs, handling carefully by holding gently at each end. Gloves are recommended to prevent skin irritation from ceramic fibers. If skin becomes irritated, wash gently with soap and water.

Item	Description	Qty.
1	Rear Log	1
2	Front Left Log	1
3	Front Right Log	1
4	Top Middle Log	1
5	Top Right Log	1
6	Top Left Log	1

1. Install Rear Log #1 on the (2) locating pins on either side of the grate. See Figure 1. Visually verify the log is securely placed on the pins and in contact with the grate. See Figure 2.

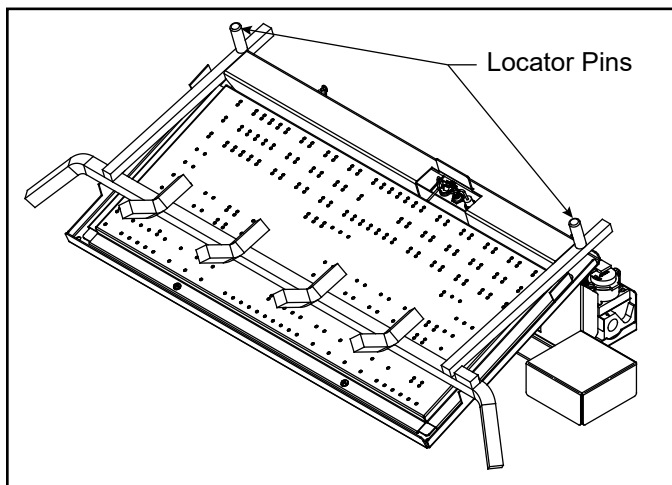

Figure 1 Locator Pins

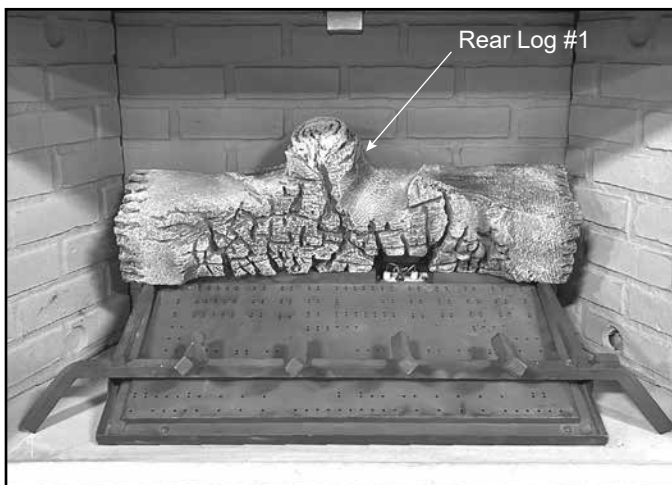

Figure 2 Rear Log #1

2. Place Front Left Log #2 on left front of grate bar aligning cutout in bottom of log with grate bar. See Figure 3.

3. Place Front Right Log #3 on the right front of grate bar, aligning cutout in bottom of log with grate bar. Make sure Front Log #3 touches Rear Log #1. See Figure 3.

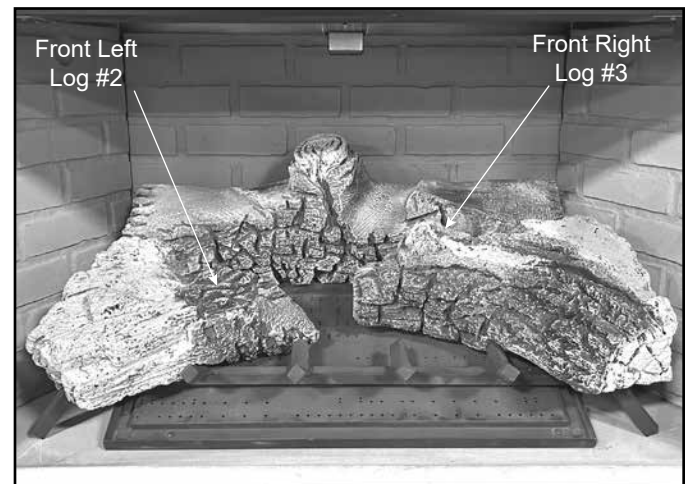

Figure 3 Front Left Log #2 & Front Right Log #3

4. Place Top Middle Log #4 on Rear Log #1. Locate the middle log against the raised area of rear log and align notch in front end with grate bar. See Figure 4.

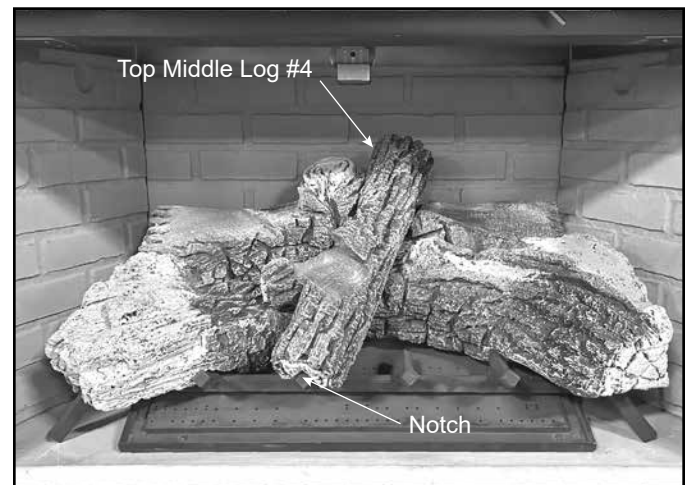

Figure 4 Top Middle Log #4

5. Rest Top Right Log #5 on Front Right Log #3.
6. Align Top Left Log #6 with notches on Front Left Log #2 and Top Middle Log #4. See Figure 5.

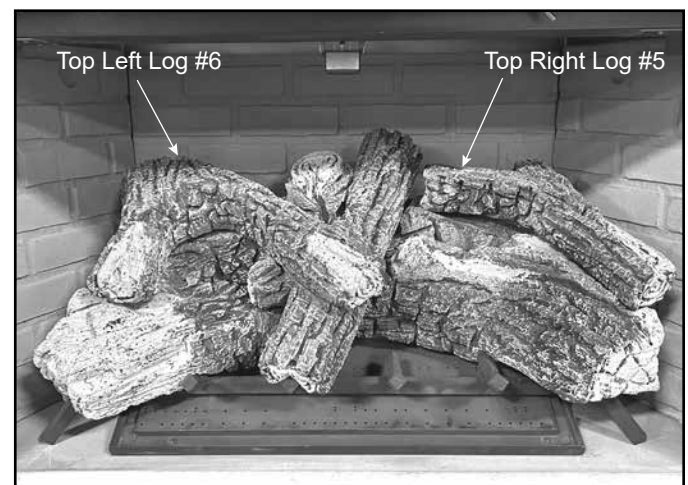

Figure 5 Top Right Log #5 & Top Left Log #6

DUZY5LS-18-24

IMPORTANT: Remove logs, handling carefully by holding gently at each end. Gloves are recommended to prevent skin irritation from ceramic fibers. If skin becomes irritated, wash gently with soap and water.

Item	Description	Qty.
1	Rear Log	1
2	Bottom Right Log	1
3	Bottom Left Log	1
4	Center Left Log	1
5	Center Right Log	1
6	Top Right Log	1
7	Top Left Log	1
8	Center Front Log	1

1. Install Rear Log #1 on the (2) locating pins on either side of the grate. See Figure 1. Visually verify the log is securely placed on the pins and in contact with the grate. See Figure 2.

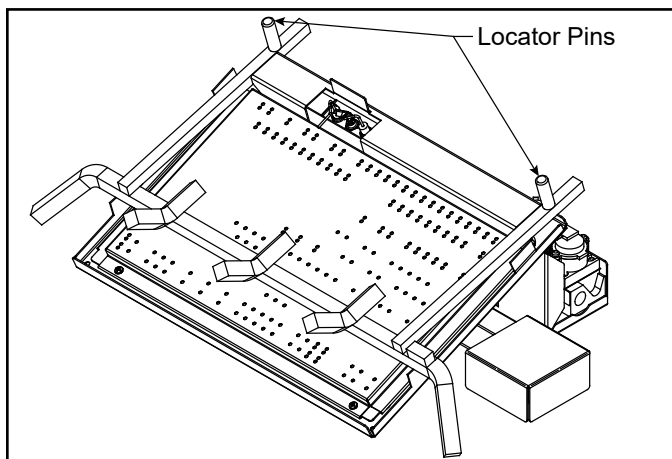

Figure 1 Locator Pins

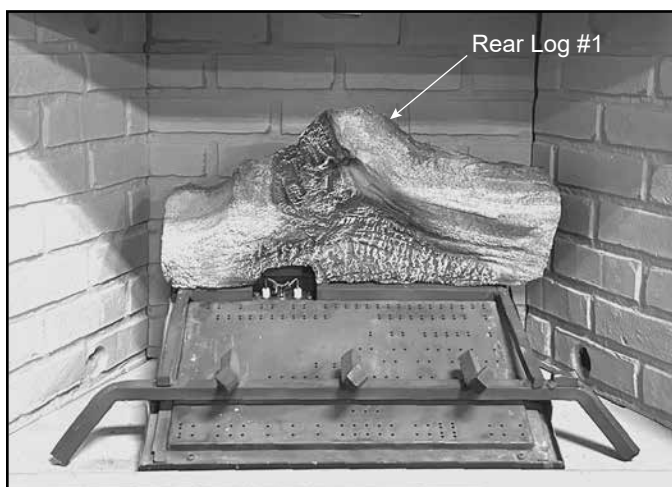

Figure 2 Rear Log #1

2. Place Bottom Right Log #2 on the right side of the grate and Bottom Left Log #3 on the left side of the grate. See Figure 3.

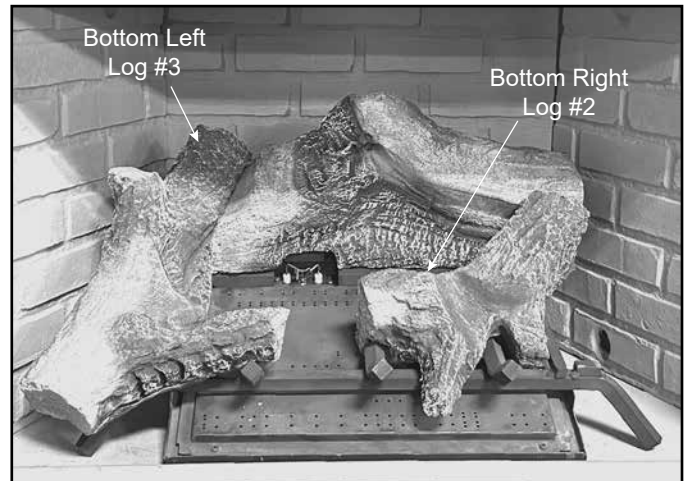

Figure 3 Bottom Right Log #2 & Bottom Left Log #3

3. Place one end of Center Left Log #4 on Bottom Left Log #3. Rest other end behind Bottom Right Log #2.
4. Place Center Right Log #5 on top of Bottom Right Log #2. See Figure 4.

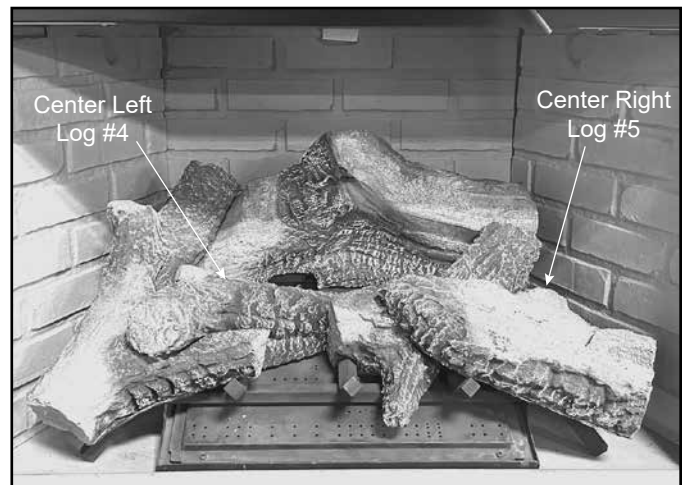

Figure 4 Center Left Log #4 & Center Right Log #5

5. Rest Top Right Log #6 on Rear Log #1 and Bottom Right Log #2.
6. Place Top Left Log #7 on Bottom Left Log #3.
7. Place Center Front Log #8 between the first and second grate prongs. See Figure 5.

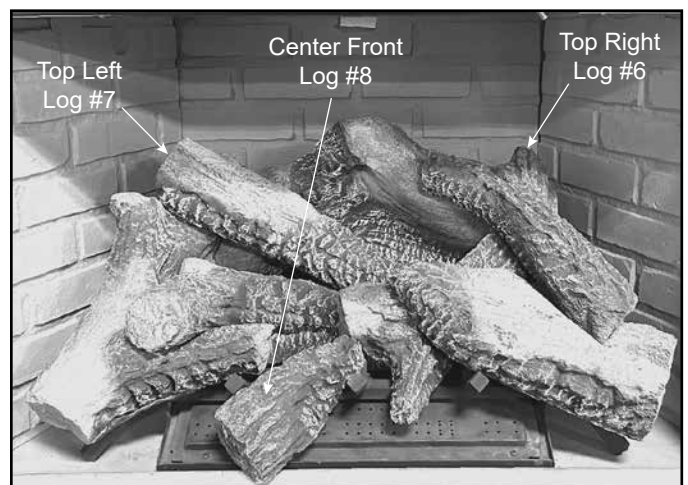

Figure 5 Top Right #6, Top Left #7 & Center Front Log #8

DUZY5LS-30

IMPORTANT: Remove logs, handling carefully by holding gently at each end. Gloves are recommended to prevent skin irritation from ceramic fibers. If skin becomes irritated, wash gently with soap and water.

Item	Description	Qty.
1	Rear Log	1
2	Bottom Right Log	1
3	Bottom Left Log	1
4	Center Left Log	1
5	Center Right Log	1
6	Top Right Log	1
7	Top Left Log	1
8	Center Front Log	1

1. Install Rear Log #1 on the (2) locating pins on either side of the grate. See Figure 1. Visually verify the log is securely placed on the pins and in contact with the grate. See Figure 2.

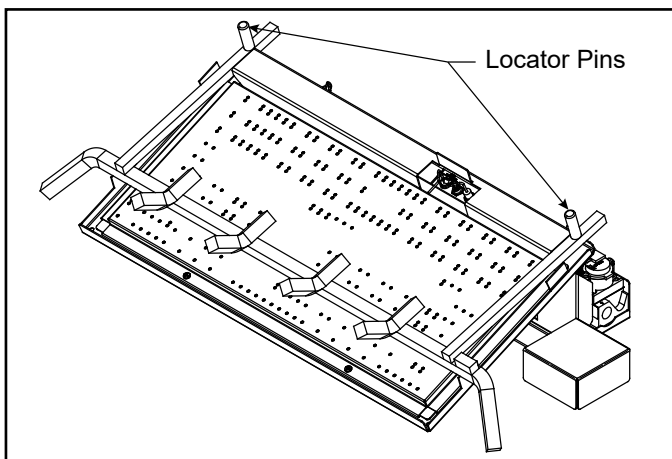

Figure 1 Locator Pins

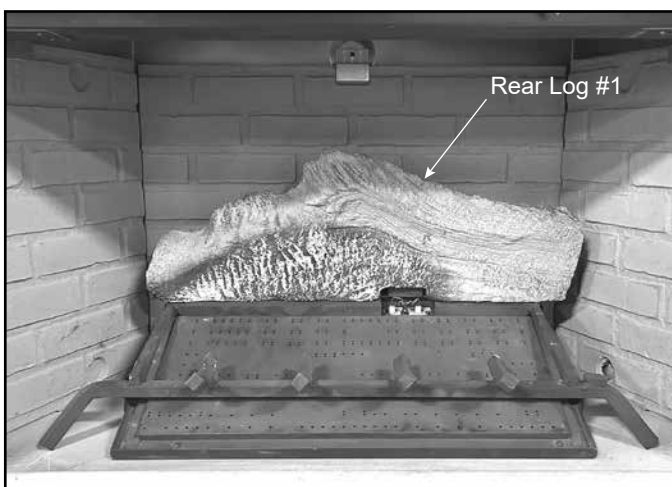

Figure 2 Rear Log #1

2. Place Bottom Right Log #2 on the right side of the grate and Bottom Left Log #3 on the left side of the grate. See Figure 3.

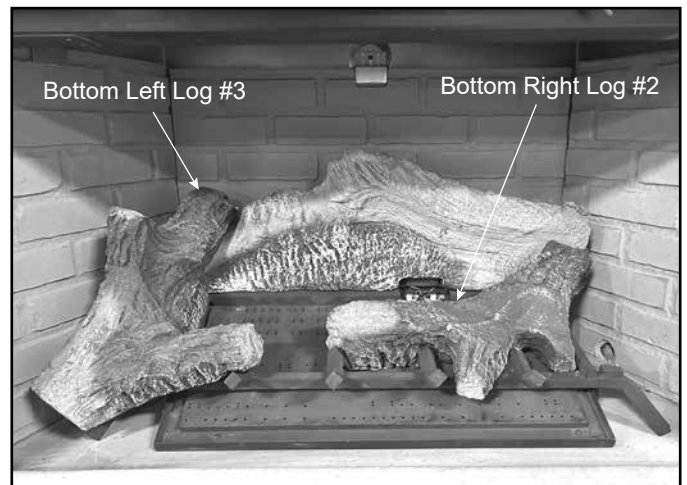

Figure 3 Bottom Right Log #2 & Bottom Left Log #3

3. Place one end of Center Left Log #4 on Bottom Left Log #3. Rest other end behind Bottom Right Log #2.
4. Place Center Right Log #5 on top of Bottom Right Log #2. See Figure 4.

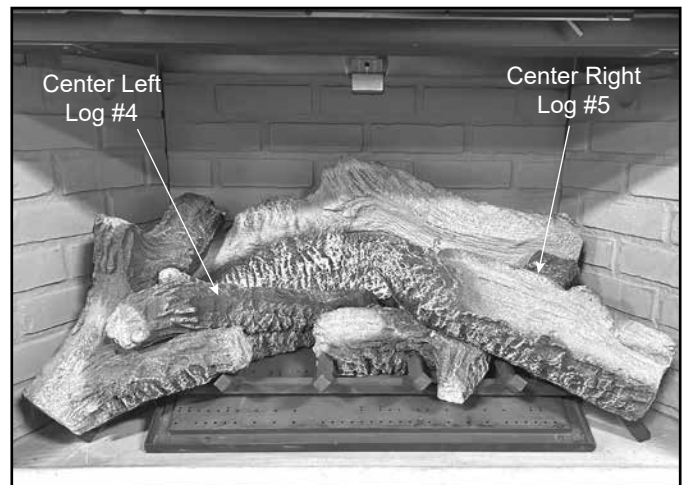

Figure 4 Center Left Log #4 & Center Right Log #5

5. Rest Top Right Log #6 on Rear Log #1 and Bottom Right Log #2.
6. Place Top Left Log #7 on Bottom Left Log #3.
7. Place Center Front Log #8 between the first and second grate prongs. See Figure 5.

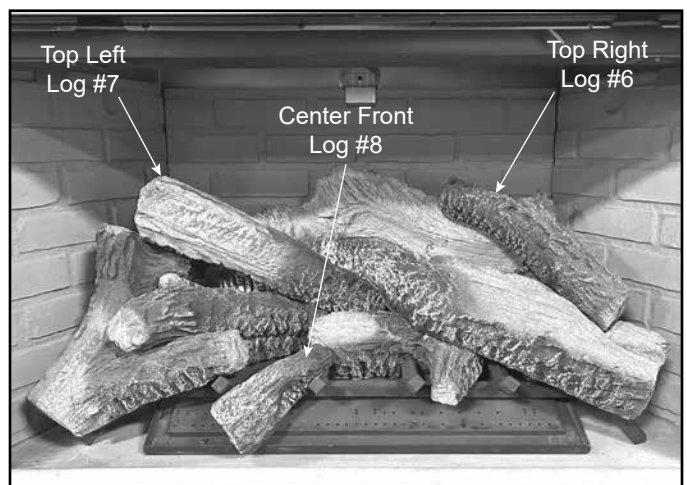
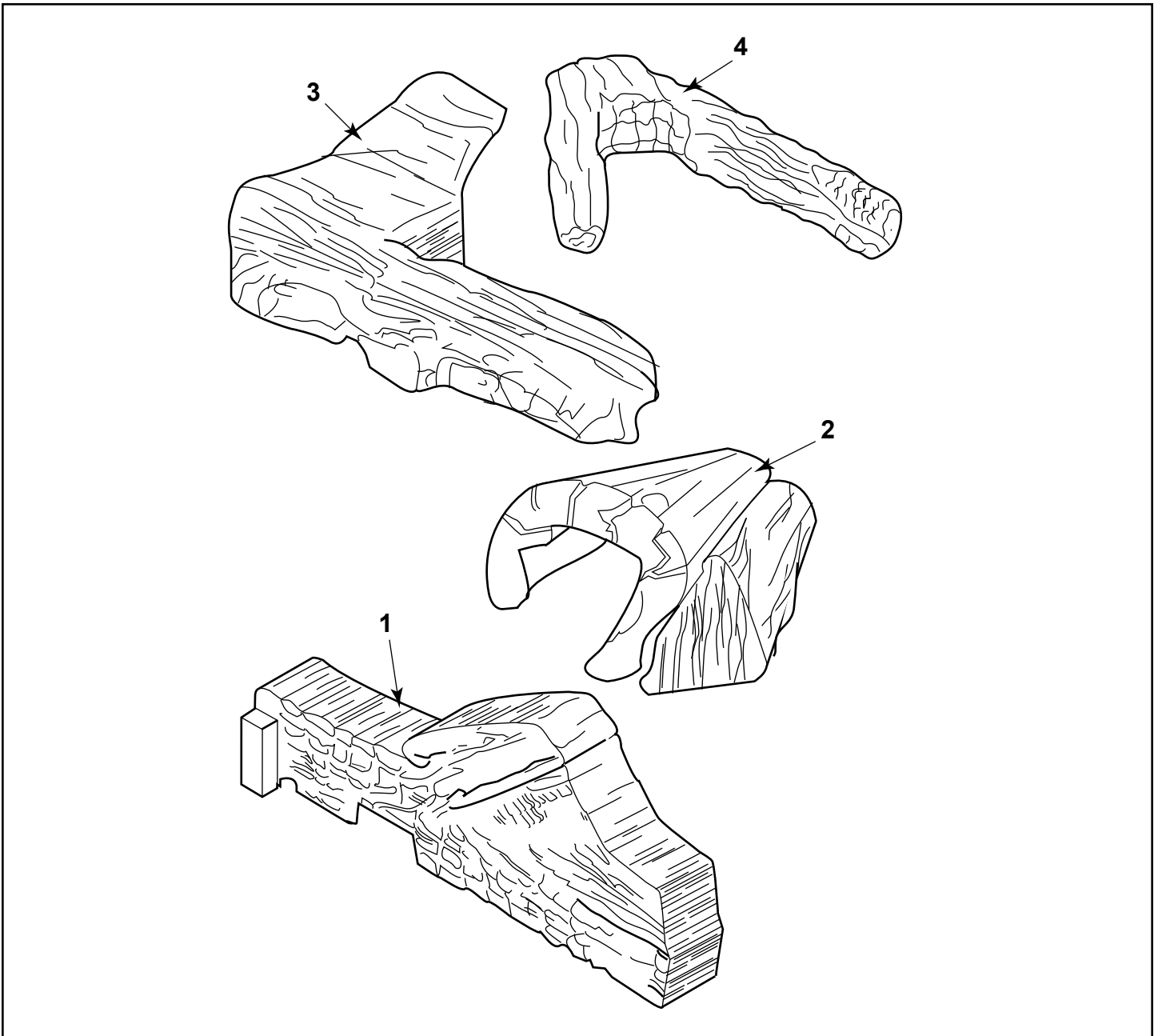

Figure 5 Top Right #6, Top Left #7 & Center Front Log #8



IMPORTANT: THIS IS DATED INFORMATION. Parts must be ordered from a dealer or distributor. **Hearth and Home Technologies does not sell directly to consumers.** Provide model number and serial number when requesting service parts from your dealer or distributor.



Stocked
at Depot

ITEM	DESCRIPTION	COMMENTS	PART NUMBER	
1	Rear Log		32D0400K	
2	Right Log		32D0401K	
3	Left Log		32D0402K	
4	Top Log		32D0403K	

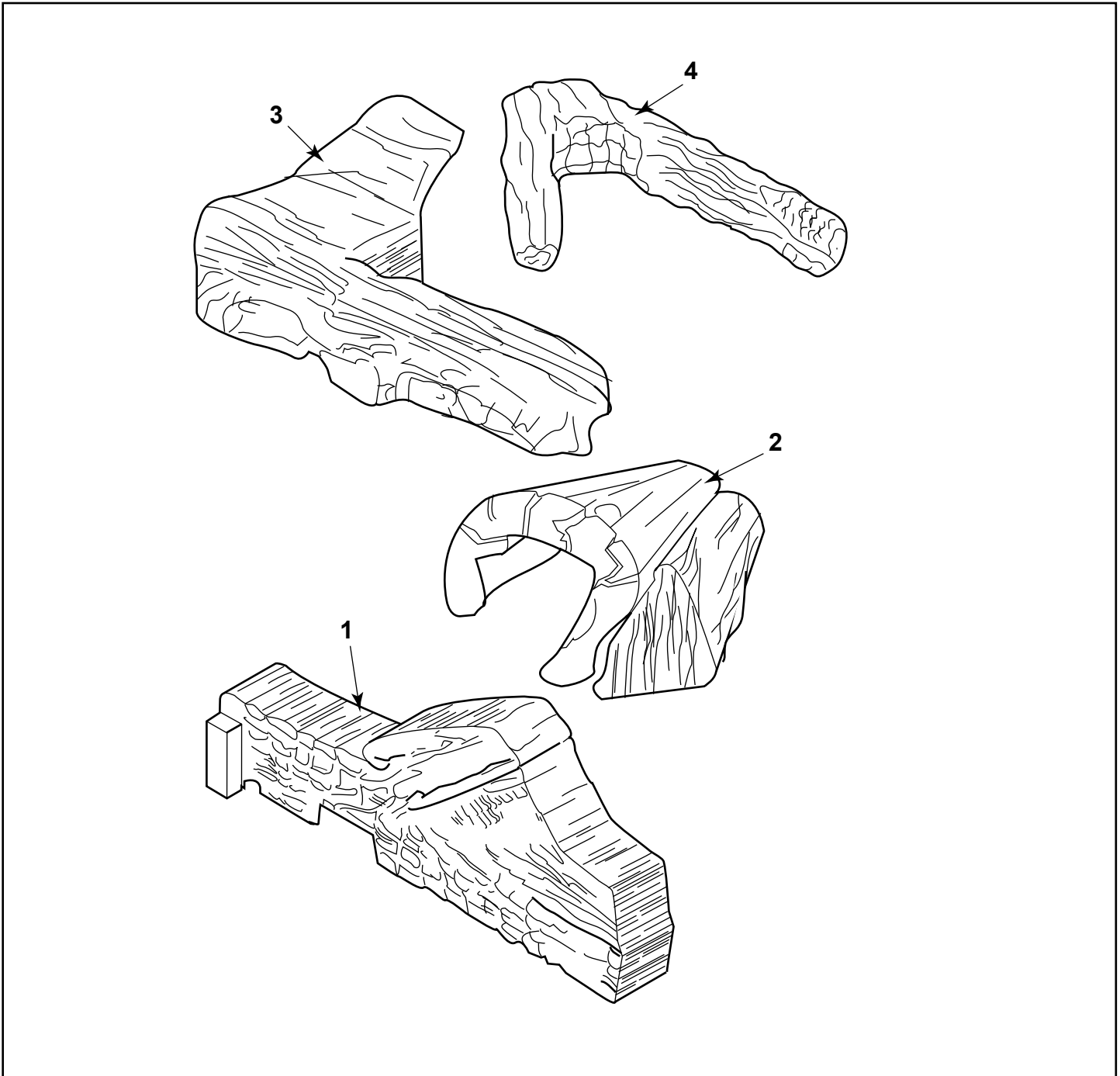

IMPORTANT: THIS IS DATED INFORMATION. Parts must be ordered from a dealer or distributor. **Hearth and Home Technologies does not sell directly to consumers.** Provide model number and serial number when requesting service parts from your dealer or distributor.



Stocked
at Depot

ITEM	DESCRIPTION	COMMENTS	PART NUMBER
1	Rear Log		32D0410K
2	Right Log		32D0411K
3	Left Log		32D0412K
4	Top Log		32D0413K

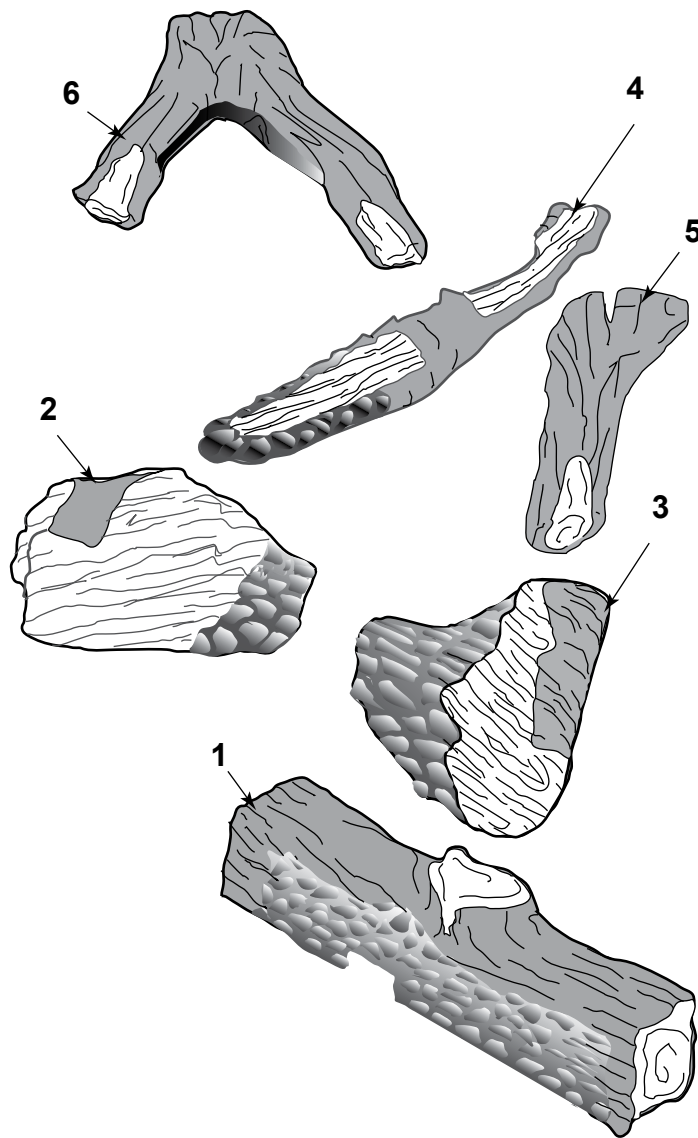

IMPORTANT: THIS IS DATED INFORMATION. Parts must be ordered from a dealer or distributor. **Hearth and Home Technologies does not sell directly to consumers.** Provide model number and serial number when requesting service parts from your dealer or distributor.



Stocked
at Depot

ITEM	DESCRIPTION	COMMENTS	PART NUMBER	
1	Rear Log		SRV32D2118-B	
2	Front Left Log		SRV32D2117-B	
3	Front Right Log		SRV32D2116-B	
4	Top Middle Log		SRV32D2114-B	
5	Top Right Log		SRV32D2113-B	
6	Top Left Log		SRV32D2115-B	

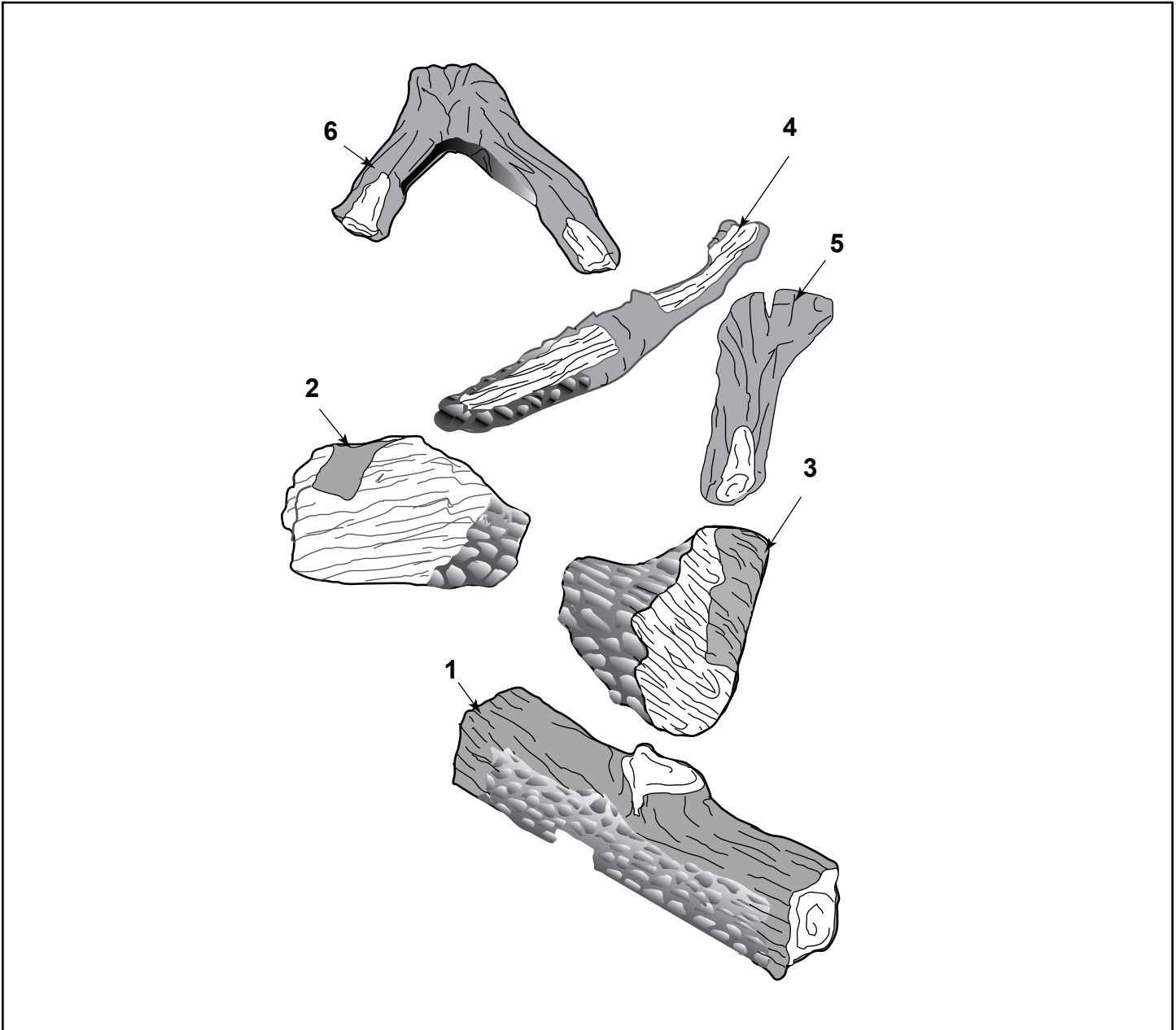

IMPORTANT: THIS IS DATED INFORMATION. Parts must be ordered from a dealer or distributor. **Hearth and Home Technologies does not sell directly to consumers.** Provide model number and serial number when requesting service parts from your dealer or distributor.



Stocked
at Depot

ITEM	DESCRIPTION	COMMENTS	PART NUMBER
1	Rear Log		SRV32D2124-B
2	Front Left Log		SRV32D2123-B
3	Front Right Log		SRV32D2122-B
4	Top Middle Log		SRV32D2120-B
5	Top Right Log		SRV32D2119-B
6	Top Left Log		SRV32D2121-B

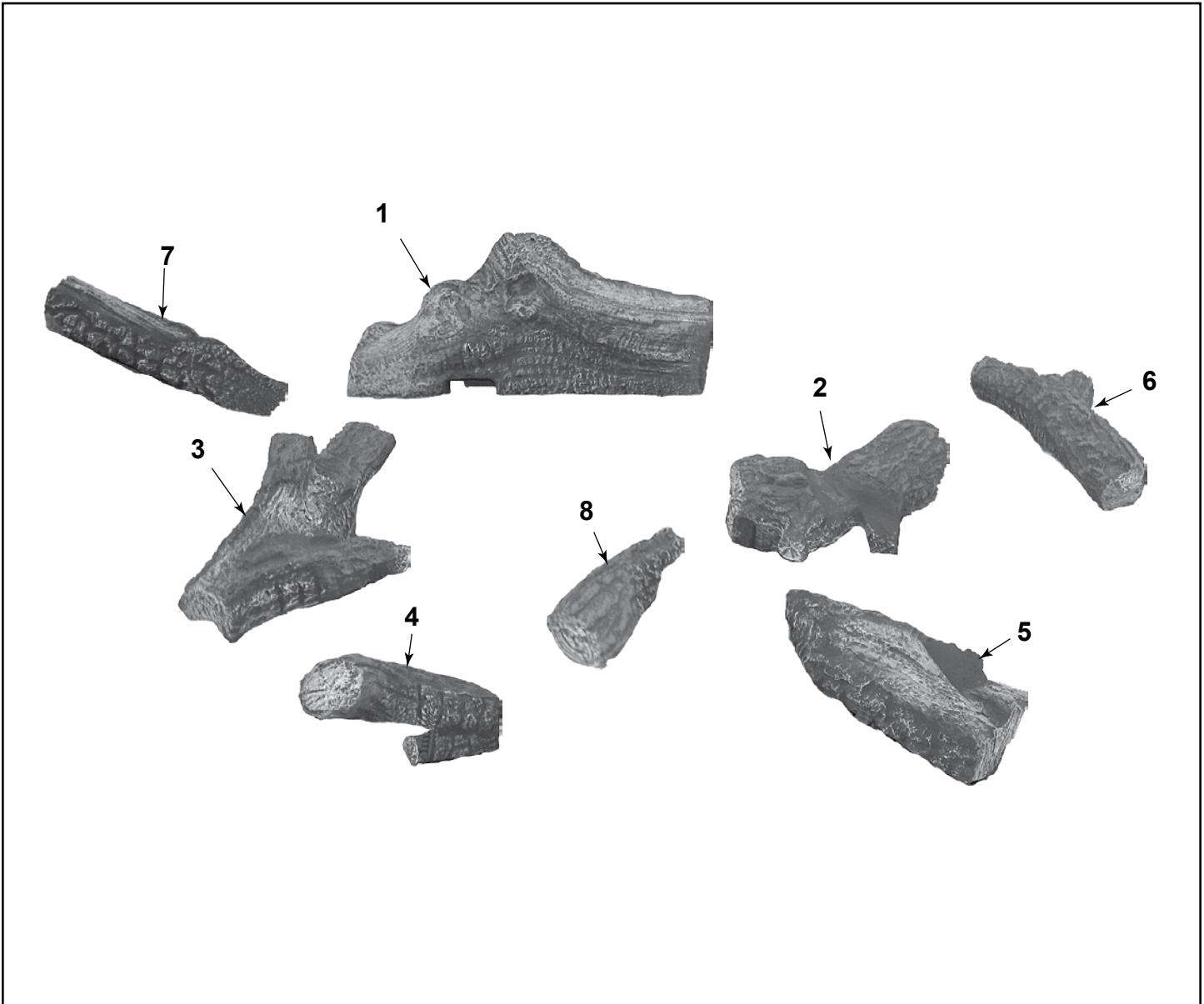

IMPORTANT: THIS IS DATED INFORMATION. Parts must be ordered from a dealer or distributor. **Hearth and Home Technologies does not sell directly to consumers.** Provide model number and serial number when requesting service parts from your dealer or distributor.



Stocked
at Depot

ITEM	DESCRIPTION	COMMENTS	PART NUMBER	
1	Rear Log		32D3121K	
2	Bottom Right Log		32D3122K	
3	Bottom Left Log		32D3123K	
4	Center Left Log		32D3124K	
5	Center Right Log		32D3125K	
6	Top Right Log		32D3126K	
7	Top Left Log		32D3127K	
8	Center Front Log		32D3128K	

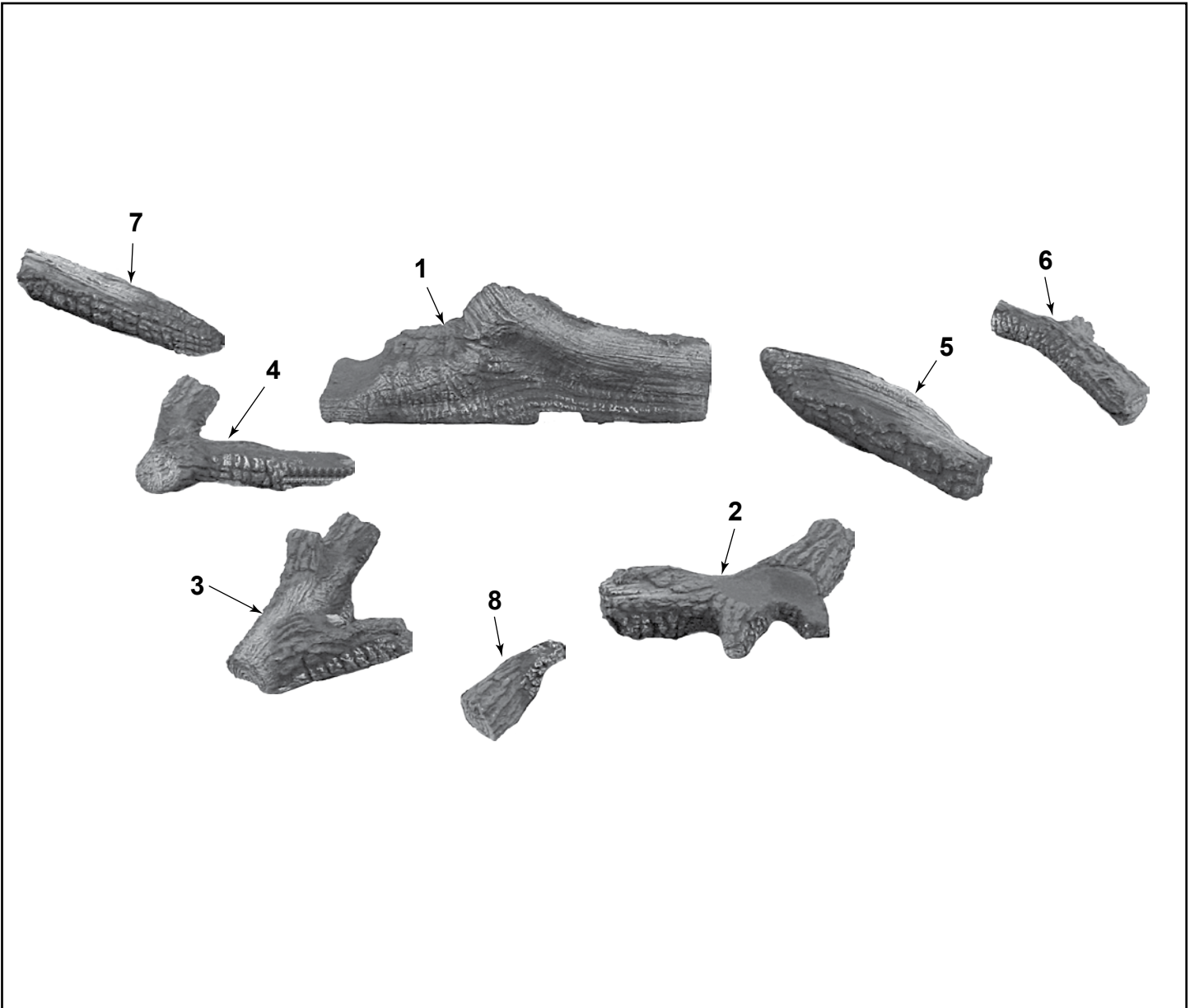

IMPORTANT: THIS IS DATED INFORMATION. Parts must be ordered from a dealer or distributor. **Hearth and Home Technologies does not sell directly to consumers.** Provide model number and serial number when requesting service parts from your dealer or distributor.



Stocked
at Depot

ITEM	DESCRIPTION	COMMENTS	PART NUMBER	
1	Rear Log		32D3131K	
2	Bottom Right Log		32D3132K	
3	Bottom Left Log		32D3133K	
4	Center Left Log		32D3134K	
5	Center Right Log		32D3135K	
6	Top Right Log		32D3136K	
7	Top Left Log		32D3137K	
8	Center Front Log		32D3138K	



Hearth & Home Technologies
7571 215th Street West, Lakeville, MN 55044
www.hearthnhome.com

Please contact your dealer with any questions or concerns.
For the location of your nearest dealer,
please visit www.hearthnhome.com.