

SKYTECH

Model: 3301PF-1

INSTALLATION AND OPERATING INSTRUCTIONS

IF YOU CANNOT READ OR UNDERSTAND THESE INSTALLATION INSTRUCTIONS DO NOT ATTEMPT TO INSTALL OR OPERATE

INTRODUCTION

This SKYTECH remote control system was developed to provide a safe, reliable, and user-friendly remote control system for gas heating appliance. The system can be operated thermostatically or manually from the transmitter. The system operates on radio frequencies (RF) within a 20-foot range using non-directional signals. The system operates one of 1,048,576 security codes that are programmed into the transmitter at the factory.

IMPORTANT:

Before operating remote control, transmitter and receiver must have matching security codes. See: LEARNING TRANSMITTER TO RECEIVER

IMPORTANT:

Review THERMO SAFETY SECTION under TRANSMITTER section and RECEIVER section. These signal/temperature safety features shut down the fireplace system when a potentially unsafe condition exists.

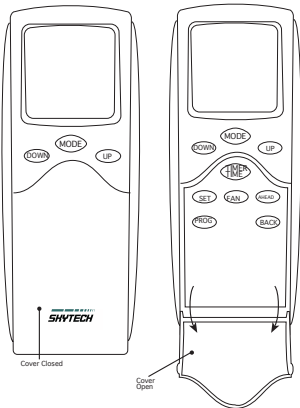

The transmitter operates on 2AAA-size 1.5V batteries. It is recommended that ALKALINE batteries always be used for longer battery life and maximum operational performance.

IMPORTANT: New or fully charged batteries are essential for proper operation of the multi-function transmitter.

Insert 2 AAA-size 1.5 V batteries into the battery compartment on the back of the transmitter, positioning the (+) and (-) ends of the batteries as indicated on the casing. When the batteries are inserted, the screen (with similar numbers) will display.

Note: If a LOW battery icon appears on the screen, check the position of the batteries; a reversed battery will activate the LOW battery icon.

LCD DISPLAY SCREEN

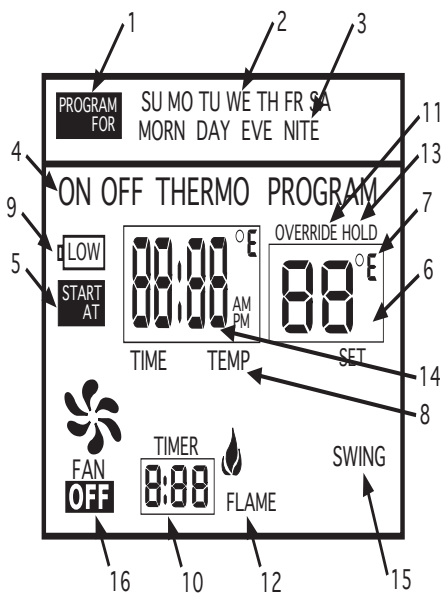

1. PROGRAM FOR: Flashes when programming days of week and periods of the day. When in normal state, only current DAY displays. When programming or in PROGRAM mode, both day and week will appear.
2. DAY –Flashes when current day or day of week is being programmed.
3. PERIOD – Flashes when current period of day or period of week is being programmed.
4. MODE – Indicates operation MODE of system - ON indicates the system is on, either manually or thermostatically – OFF indicates the entire system is turned off - THERMO indicates the system will automatically cycle ON/OFF, depending on programmed SET temperature - PROGRAM – indicates the system is operating with PROGRAMMED settings.
5. START AT – Flashes when programming the time to turn system ON.
6. SET – Indicates desired SET room temperature, when in THERMO or PROGRAM mode.
7. F⁰/ C⁰ – Factory programmed in F⁰. (C⁰ indicates degrees in Celsius)
8. TIME/TEMP – Displays the CURRENT room temperature. In same frame, the current time will display in AM or PM. You must depress the TIME/TIMER button to display current time.
9. LOW – Battery power is low. Replace batteries within 2 weeks.
10. TIMER – When displayed, indicates countdown timer in operation.
11. OVERRIDE – Displays when “programmed” SET temperature is overridden.
12. FLAME – Single flame symbol indicates burner/valve is operational.
13. HOLD – Displays when “programmed” SET temperature is

- overridden and will hold that temperature until cancelled.
- 14. CP – Displays when CHILD PROOF “LOCK OUT” is engaged. Pressing the UP and TIMER buttons together, engages CP.
- 15. SWING- Displays in SET frame when setting TEMPERATURE DIFFERENTIAL.
- 16. FAN – Indicates the fan is ON (when fan blade displayed), the word OFF indicates fan is OFF.

FUNCTIONS

Display

LCD – Liquid Crystal

To operate the system, press the MODE button on the transmitter to select the operational MODE desired.

- ON indicates the system is on, either manually, timed, thermostatically, or program.
- THERMO indicates the system will automatically cycle ON/OFF, depending on programmed set temperature.
- OFF indicates the entire system is turned off.
- PROGRAM indicates the system will automatically cycle ON/OFF in the programmed mode depending on the 7 day/4 period program that is in memory.

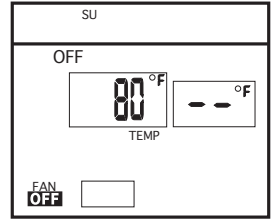

BUTTON SETTINGS

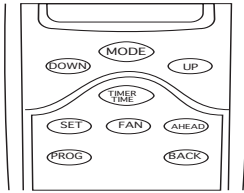

Flip open the plastic cover on the front of the transmitter to expose the “SET” buttons. The flip cover protects the SET buttons from being changed accidentally. Close the cover after completing the following settings/ programming.

Flashing numbers on the display indicate the system is awaiting user input, such as using the UP and DOWN buttons to program a new setting. If no change is made to flashing digits within 15 seconds, the system will complete the procedure last programmed and reset the display to its normal state.

INITIAL SET-UP PROGRAMMING OF TRANSMITTER

Follow the procedures below, upon FIRST USE of transmitter, setting the following program options:

- TEMPERATURE SETTING - F⁰ (Fahrenheit) or C⁰ (Celsius)
- CURRENT DAY OF WEEK – SU, MO, TU, WE, TH, FR, SA
- CURRENT TIME OF DAY –Hours and minutes

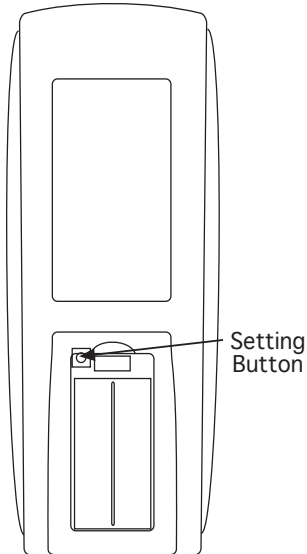

To program settings, first remove the battery cover on the back of the transmitter. If you have not already installed the 2-AAA batteries, this would be a good time to do so. Note the small push button at the upper left side of the battery compartment. This is the button used to perform the initial transmitter programming. You will need to use a paper clip or sharp end of a pencil to depress this button.

CHANGING THE TEMPERATURE SCALE

1. Press setting button on back of transmitter ONCE and the ⁰F symbol will begin flashing on the LCD screen, You may replace the battery cover at this time.
2. To change ⁰F to ⁰C, press the UP or DOWN button on the front of the transmitter, After setting/confirming the preferred temperature SCALE, press the SET button on the front of the transmitter.

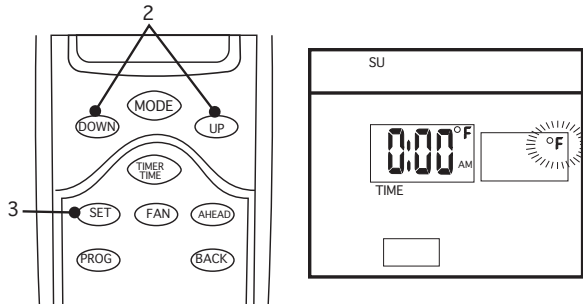

NOTE: You will need to press the SET button, confirming ⁰F if you want the temperature readings to be in ⁰F.

SETTING THE CURRENT DAY OF THE WEEK

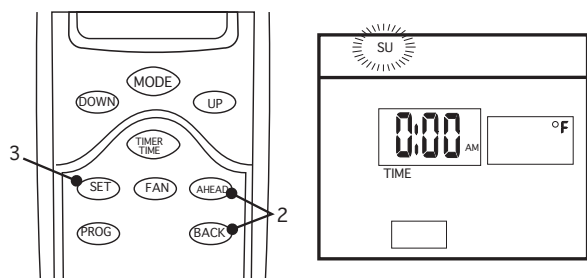

1. Following Step 2 above, the symbol SU will begin flashing on the LCD screen.
2. To change to the CURRENT day of the week, press the AHEAD or BACK button on the front of the transmitter.
3. After setting/confirming the current Day of the week, press the SET button on the front of the transmitter.

NOTE: You will need to press the SET button, confirming SU, if that is the current day.

SETTING THE CURRENT HOUR AND MINUTES

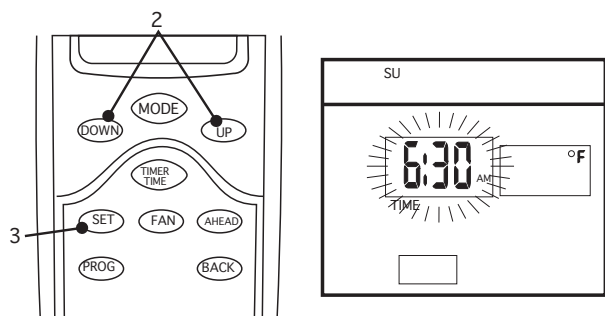

1. Following Step 3 on the previous page the HOUR digits will begin flashing in the TIME frame on the LCD screen.
2. To set the current HOUR, press the UP or DOWN button setting the HOUR for the corresponding AM/PM time period.
3. After setting the current HOUR, press the SET button on the front of the transmitter, and the MINUTE digits will begin flashing on the LCD screen.
4. To set the current MINUTES, press the UP or DOWN button setting to the correct MINUTES.
5. After setting the HOURS and MINUTES, press the SET button on the front of the transmitter.

The initial set-up/programming of the transmitter is now complete. Be sure the slide-on battery cover is reinstalled and proceed to the next step. The LCD screen will now display in its normal state.

PROGRAM OPERATION OF REMOTE CONTROL

BUILT -IN FACTORY PROGRAM

DAY	PERIOD	TIME/TEMP
All 7 Days	MORN	6:00 AM 70°
Factory- Programmed	DAY	8:30 AM 60°
	EVE	3:00 PM 70°
	NIGHT	11:00 PM 63°

BUILT-IN PROGRAM

The transmitter has a factory program built in. Each day has been broken into four periods and each period has its own starting time and temperature. A chart of the built- in programs is at the left.

You may change any of the factory settings by following the procedures below. Should you wish to return to the factory program, follow the procedures under heading PROGRAM REVIEW or PROGRAM CANCELLATION depending on which process you select.

PROGRAMMING DAYS/PERIOD OF DAY/SET TEMPERATURES

CUSTOM PROGRAM (BY USER)

PROGRAMMING THE TRANSMITTER

The user may change the built-in time and temperature programs to suit their personal schedule. Each day is divided into four periods: MORNING, DAY, EVENING, AND NIGHT. A blank programming chart is provided below to record your customized time and temperature settings.

If desired, you may change a single day or all seven days that have the built-in factory program. To change one or all seven days, complete the following steps:

	PERIOD				
DAY	MORN	DAY	EVE	NITE	TIME/TEMP
SU					
MO					
TU					
WE					
TH					
FR					
SAT					

1. Press the **PROG** button for 4 seconds. The shaded boxes on the LCD screen with the words **PROGRAM FOR** and **START AT** will begin to flash. The current **DAY**, **PERIOD**, **TIME** and **SET** temperature of the **BUILT-IN FACTORY PROGRAM** will also be displayed.

NOTE: If the above settings were not previously completed during the initial **SET-UP** and **PROGRAMMING** procedure, then the LCD screen will display **SU**, **MORN**, **TIME** and **SET** temperature digits. You must go back and perform the initial set-up procedure or the remote will not operate properly in the **PROGRAM** mode. SEE PAGE 2.

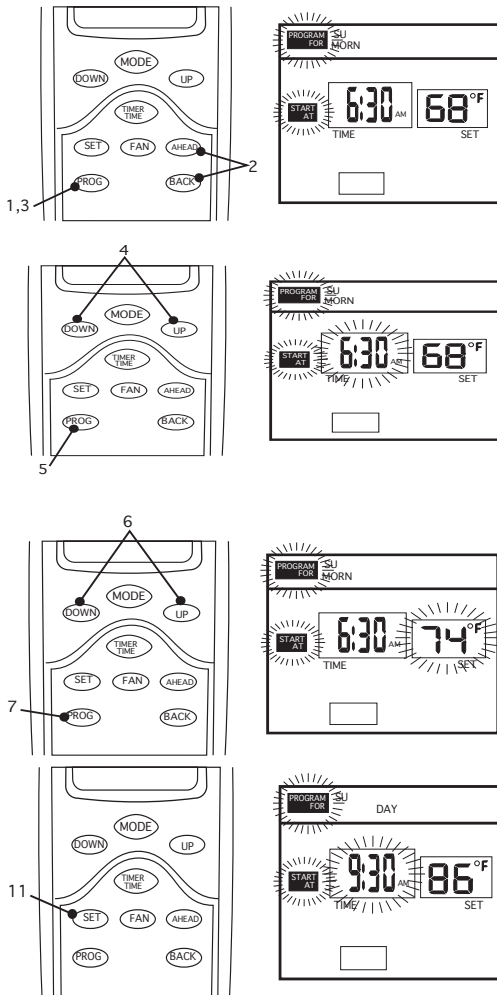

2. To program the **DAY** and **PERIOD OF DAY**, press the **AHEAD** or **BACK** buttons to display the **DAY** and **PERIOD** you wish to program.
3. When the **DAY** and **PERIOD** being programmed displays, then press the **PROG** button and the **TIME** will flash on the LCD screen.
4. To program the **START TIME**, press the **UP** or **DOWN** button. Programmed start time settings are in 15-minute segments. The new set time will display on the LCD screen.
5. When the desired **START TIME** displays press the **PROG** button and the **SET TEMPERATURE** will flash on the LCD screen.
6. To program the **SET TEMPERATURE**, press the **UP** or **DOWN** button.
7. When the desired **SET TEMPERATURE** displays, then press the **PROG** button.
8. After pressing the **PROG** button in step 7, the next **PERIOD** of the same or next day will display on the LCD screen.
9. To program the next **PERIOD** follow steps 3, 4, 5, 6 and 7.
10. Continue to follow steps 3, 4, 5, 6 and 7 until all 7 days and the 4 time periods in each day are programmed.
11. Once **ALL** the programming has been completed, then press the **SET** button. The programming data that has been entered will now **over-ride** the factory built-in program and operate your remote control system.

PROGRAMMING NOTE:

Once in the programming process and you want to advance the programming procedure, you may bypass some of the **DAYS** or **PERIODS OF DAY**, by pushing the **AHEAD** or **BACK** buttons. This allows you to eliminate the need to enter the **TIME** and **TEMPERATURE** for each **DAY/PERIOD** speeding up the programming process by skipping some of the "software prompts". Once the LCD screen displays a **DAY/PERIOD** you want to reprogram, press the **PROG** button and follow the programming steps outlined above.

PROGRAM REVIEW

If you want to review the settings for either the **FACTORY** program and/or your **CUSTOMIZED** program, you may do so by pressing the **PROG** button for one second. To review other settings, press the **PROG** button allowing one second between each press of the **PROG** button. If you press the **PROG** button for 4 seconds, then you go into the programming process. Press the **SET** button should you hold the **PROG** button too long.

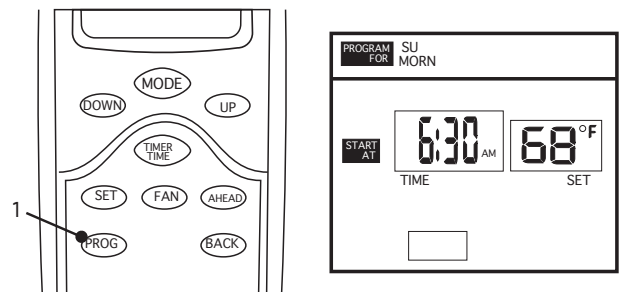

PROGRAM CANCELLATION

Should you want to cancel the CUSTOMIZED program that you have entered and return to the FACTORY program, you may do so. To cancel a CUSTOMIZED program:

1. Press the SET button to make sure the LCD screen is in normal state.
2. Then press and hold the PROG button and, at the same time, press the SET button for a period of 10 seconds.
3. The customized programs will be cancelled when the display icons/numbers flash with some icons disappearing. The LCD screen will begin flashing PROGRAM FOR, START AT, and the digits in the TIME and SET frames will begin flashing. This confirms CUSTOMIZED programs have been cancelled.
4. Push the SET button to return LCD screen to normal state or wait 10 seconds and LCD screen will return to normal state automatically.

ADDITIONAL PROGRAMMING OPTIONS

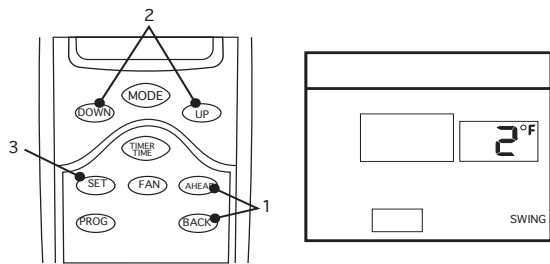

SWING (TEMPERATURE DIFFERENTIAL)

The thermo-transmitter operates the fireplace system whenever the ROOM TEMPERATURE varies a certain number of degrees from the SET TEMPERATURE. This variation is called the “SWING” or TEMPERATURE DIFFERENTIAL. The normal operating cycle of a fireplace system may be 2-4 times per hour depending on how well the room or home is insulated from the cold or drafts. A smaller “swing number” increases the number of cycles so the room temperature is more constant. A larger “swing number” decreases the number of cycles, which saves energy, in most cases. The factory setting for the “swing number” is 2. This represents a temperature variation of +/- 2 °F (1 °C) between SET temperature and ROOM temperature, which determines when the fireplace will be activated. The “SWING” number values are:

1 = +/- 1 °F (.5 °C), 2 = +/- 2 °F (1 °C), 3 = +/- 3 °F (1.6 °C).

MANUAL CHECK OF “SWING” OR TEMPERATURE DIFFERENTIAL

The operation of the factory set “THERMO SWING” can be checked by adjusting the SET TEMP 2 °F above or below the room temperature. This will cause the system to turn ON or OFF. Normally the system will only respond to temperature changes every two minutes. Manually changing the SET temperature will activate the system in less than 10 seconds. If the “SWING” is changed, then a new room temperature differential will respond. Factory setting of SWING temperature is 2 °F.

1. To change the temperature “SWING” setting (1-3), press the AHEAD + BACK buttons simultaneously to display the current “SWING” setting in the SET TEMP frame. The word SWING will display on the LCD screen.
2. Press the UP or DOWN button to change the temperature differential or “SWING” (1-3). See above for 1-3 “SWING” temperature values.
3. To store the “swing number”, press the SET/RETURN button or allow 15 seconds to lapse, and the new “swing number” will be automatically programmed.

NOTE: When the gas fireplace system is activated, a FLAME icon will display on the LCD screen indicating a signal has been sent from the TRANSMITTER.

OPERATING INSTRUCTIONS

THERMO OPERATION – (Systems operates thermostatically based on SET TEMP setting, ONLY)

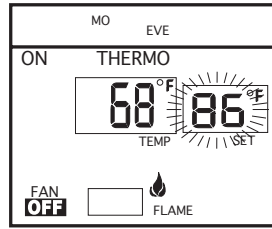
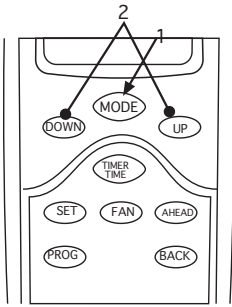

SETTING DESIRED ROOM TEMPERATURE

This remote control system can be thermostatically controlled when the transmitter is in the THERMO mode (THERMO must be displayed on the screen).

1. To set the DESIRED room temperature, press the MODE button to place the transmitter into THERMO mode. THERMO ON or OFF will display.
2. Then press the UP or DOWN button to select the DESIRED room temperature. The highest SET temperature is 99 °F (32 °C). The lowest SET temperature is 45 °F (6 °C).
3. The TRANSMITTER will “sense” the room temperature every two minutes automatically turning the fireplace ON or OFF thermostatically.

MANUAL CHECK OF THERMO OPERATION

The operation of the Thermo setting can be checked on demand by adjusting the SET temperature 2 °F above or below the room temperature, which will cause the system to turn ON or OFF, respectively. Normally, however, the system will only respond to temperature changes every two minutes. NOTE: if “SWING” number has been changed, then activation will occur at the new “SWING” setting.

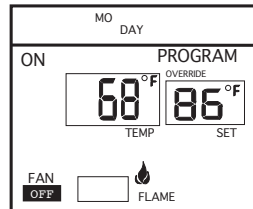
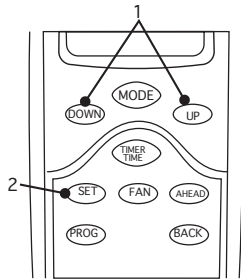

TEMPERATURE OVERRIDE – (Operates only in PROGRAM mode)

The user may change the current SET temperature without changing the programs stored in the transmitter’s memory. The OVERRIDE feature will be automatically cancelled at the start of the next PROGRAM PERIOD.

1. To change current SET TEMP, press the UP or DOWN button. (Setting will be cancelled automatically when next program period begins.) The word OVERRIDE will appear over the SET frame on the LCD.
2. To cancel temperature OVERRIDE, press SET button.

TEMPERATURE HOLD – (Operates only in PROGRAM mode.)

The user may override the SET temperature during any period, adjusting the SET temperature to a CONSTANT new SET/HOLD temperature.

1. Press the UP or DOWN button to change the SET temperature to the level desired. The word OVERRIDE will appear in SET frame on the LCD.
2. To HOLD the new temperature at a CONSTANT setting, push the UP and DOWN buttons TOGETHER to activate the HOLD function. The word HOLD will appear over the SET frame and the word OVERRIDE will disappear.
3. To cancel OVERRIDE or HOLD, press the SET button.

TIME OF DAY DISPLAY

1. To check the current TIME of day, press the TIMER/TIME button on the transmitter for less than 1 second. The current TIME of day will appear in the TIME/TEMP frame replacing the temperature reading.

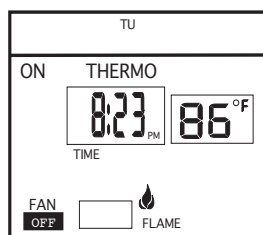
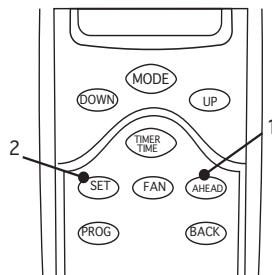
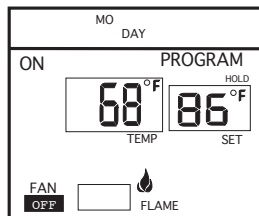
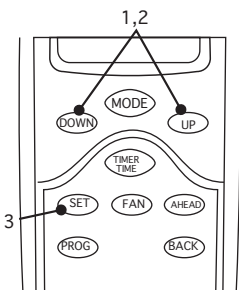

- The TEMPERATURE will reappear in 15 seconds, or you can press the SET button to cancel the display of the time.

SETTING THE COUNTDOWN TIMER

This remote control can operate with a built-in, countdown timer when the transmitter is in the ON or THERMO mode (THERMO or ON must be displayed on the LCD screen). DO NOT operate in PROGRAM MODE as times are pre-programmed into the transmitter.

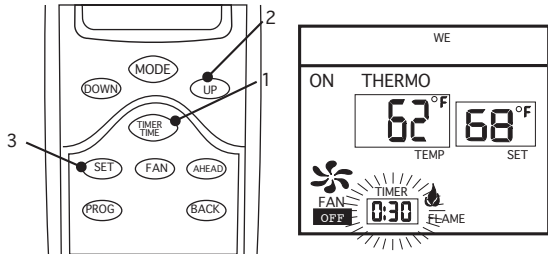

- Press the TIMER/TIME button on the transmitter for more than 2 seconds. The word TIMER and 0:15 flash on the LCD screen.
- Press the UP or DOWN button on the transmitter to begin advancing through each of the countdown time options. Available countdown times are 15 min., 30 min, 45 min, 1 hr, 1 hr 30 min, 2 hr, 2 hr 30 min, and each additional half hour up to nine hours.
- To set the TIMER press the SET button on the transmitter. If the system is ON, it will remain on until the “timer time” has expired. If the system is in the THERMO mode, it will cancel ON and OFF, as the room temperature requires until the “timer time” has expired.
- To cancel the TIMER operation, press the TIMER/TIME button for more than 2 seconds.

OPERATIONAL NOTE: When the TIMER is used in the THERMO mode, the THERMO operation will discontinue only when the “countdown time” has expired.

OPERATING FAN (Operates only in ON/THERMO/ PROGRAM MODES)

This remote control system has the capability of operating a 110 VAC fan or blower system that may be included with your gas appliance. It only operates an ON/OFF function for the fan/blower and cannot operate a variable speed controller. When properly connected to the remote receiver, the fan will only go ON or OFF by remote. You may still be able to vary the speed of the fan/blower motor at the appliance, but not remotely with the transmitter.

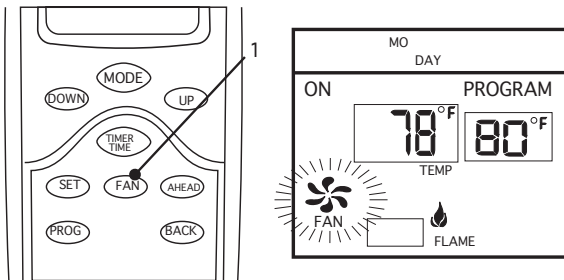

- To turn the fan ON, press the FAN button on the transmitter, When the fan is operating, the fan blade will display.
- Press FAN button to turn fan OFF, When the fan is off, OFF will display on the LCD screen below the word FAN. When the transmitter is in the THERMO or PROGRAM modes and the FAN button is pressed to ON, the FAN will operate ON and OFF as the cycling of the THERMO or PROGRAM occurs.
- IF the Fan is in the OFF position, the fan will not operate until activated by the FAN button.

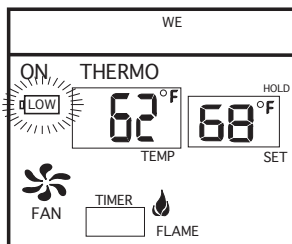

LOW/BATTERY INDICATOR

The word LOW outlined by a battery on the left side of the LCD screen will appear when battery power has dropped significantly. At this time, approximately two weeks of battery power remains until the transmitter may experience partial or complete loss of functions. NOTE: A reversed battery will activate the LOW battery icon.

TRANSMITTER

OPERATING SAFETY MONITORS: SYSTEMS SHUTDOWN

The SKYTECH remote control operates on RF (radio frequency) signals that are sent by the TRANSMITTER (remote) to the RECEIVER that operates the appliance. It is recommended that the TRANSMITTER always be located within the 20 foot operating range, preferably in the same room in which the appliance is located.

THERMO UPDATING FEATURE –TRANSMITTER – (T/S –TX)

This SKYTECH remote control has a THERMO UPDATING Feature built into its software. The THERMO UPDATING Feature operates in the following manner, but only in the THERMO and PROGRAM MODES:

The transmitter normally reads the ROOM temperature every 2 minutes checking the ROOM temperature against the SET temperature it sends a signal to the receiver.

THERMO-SAFETY FEATURE –TRANSMITTER – (T/S –TX)

This SKYTECH remote control has a THERMO-SAFETY function built into its software. It provides an extra margin of safety when the fireplace system is in the THERMO, TIMER, and PROGRAM MODES. The THERMO-SAFETY feature is activated when the TRANSMITTER is moved beyond the maximum recommended operating range, which is 20 feet. It is also activated when the batteries become weak or are removed from the transmitter.

The THERMO-SAFETY operates in the following manner, but only in the ON, THERMO, TIMER, and PROGRAM MODES:

The receiver is thermally protected from extreme heat conditions. Heat can have a negative effect on the operation of the receiver's microprocessors.

When the ambient temperature at the THERMISTOR, *inside the receiver case*, reaches 130⁰ F, the THERMISTOR will automatically shut the appliance down and the RECEIVER will begin emitting a series of 4 "beeps", every 2 seconds. When the ambient temperature, at the RECEIVER, drops between 120⁰ F and 130⁰ F, the user can reactivate the appliance by pushing the MODE button on the transmitter. The word ON must display on the LCD screen. When the MODE button is pressed to ON, the THERMISTOR "resets" itself and the fireplace will begin operating again. However, the "beeping" will continue, if the ambient temperature remains between 120⁰ F and 130⁰ F. This "beeping" alerts the user that the RECEIVER should be repositioned so the ambient temperature drops below 120⁰ F.

When the temperature drops below 120⁰ F, the "beeping" will cease, providing the user has "reset" the THERMISTOR by pushing the MODE button to ON to operate the appliance, either manually or thermally. Allow sufficient time for the receiver to cool below 120⁰ F, and then press the MODE button to stop beeping.

To "reset" the RECEIVER and operate the fireplace system, you must press the MODE button on the transmitter. The word ON must display on the LCD screen. By turning the system to ON, the THERMO-SAFETY operation is overridden and the system will return to normal operation depending on the MODE selected at the transmitter. The THERMO SAFETY feature will reactivate should the transmitter be taken out of the normal operating range or should the transmitter's batteries fail or be removed.

We recommend the user check the batteries in the TRANSMITTER to make sure the voltage is no less than 2.5 volts.

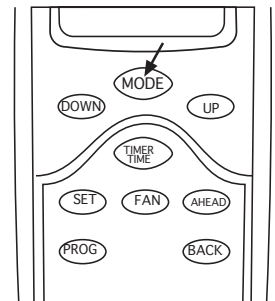

COMMUNICATION – SAFETY – TRANSMITTER – (C/S – TX)

This SKYTECH series remote controls has a COMMUNICATION –SAFETY function built into its software. It provides an extra margin of safety when the TRANSMITTER is out of the normal 20 foot operating range of the receiver.

The COMMUNICATION – SAFETY feature operates in the following manner, in all OPERATING MODES – ON/THERMO/TIMER/PROGRAM.

At all times and in all OPERATING MODES, the transmitter sends an RF signal every fifteen (15) minutes, to the receiver, indicating that the transmitter is within the normal operating range of 20 feet. Should the receiver NOT receive a transmitter signal every 15 minutes, the IC software, in the RECEIVER< will begin a 2-HOUR (120-minute) countdown timing function. If during this 2-hour period, the receiver does not receive a signal from the transmitter, the receiver will shut down the fireplace being controlled by the receiver. The RECEIVER will then emit a series of rapid "beeps" for a period of 10 seconds. Then after 10 seconds of rapid beeping, the RECEIVER will continue to emit a single "beep" every 4 seconds until a transmitter signal is

again received. The intermittent 4 second beeping will go on for as long as the receiver's batteries last which could be in excess of one year.

To "reset" the RECEIVER and operate the fireplace system, you must press the MODE button on the transmitter. The word ON must display on the LCD screen. By turning the system to ON, the COMMUNICATION -SAFETY operation is overridden and the system will return to normal operation depending on the MODE selected at the transmitter the COMMUNICATION - SAFETY

feature will reactivate should the transmitter be taken out of the normal operating range or should the transmitter's batteries fail or be removed.

The COMMUNICATION -SAFETY feature operates in all OPERATING MODES and can be considered a back up to the THERMO-SAFETY feature previously described.

REMOTE RECEIVER

IMPORTANT: THE REMOTE RECEIVER SHOULD BE POSITIONED WHERE AMBIENT TEMPERATURES INSIDE THE RECEIVER DO NOT EXCEED 130 DEGREES F.

The remote receiver is powered by 110-120 VAC. For operational functions and personal safety, the receiver must be properly grounded. The receiver's power cord is equipped with a three-prong (grounding) plug which mates to a standard three-prong (grounding) receptacle minimizing the possibility of electrical shock hazard. Some fireplace products require a grounded circuit to operate.

WARNING: Improper use of the grounding plug can result in a shock. Do not use a 2-prong adapter to accept the 3-prong plug from the receiver. The customer should have the fan/blower receptacle in the FIREPLACE checked by a qualified electrician to make sure the receptacle is properly grounded and correctly polarized.

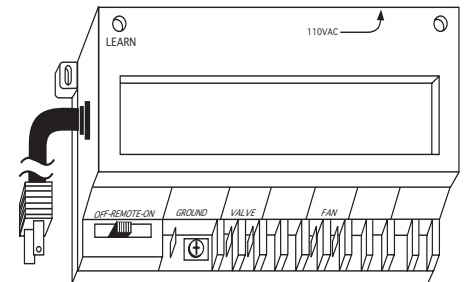

CAUTION: All wiring should be done by a qualified electrician and shall be in compliance with local codes and with the National Electric Code ANSI/NFPA No. 70-current (in the United States), or with current CSA C22.1 Canadian Code (in Canada).

WARNING: DO NOT CONNECT 110-120 VAC WIRING TO THE GAS CONTROL VALVE OF THIS APPLIANCE.

The remote receiver houses the integrated circuits that respond to commands from the transmitter to control system operation. It has a 3-position-slide switch to select the MODE of operation: OFF/REMOTE/ON.

1. With the slide switch in the ON position, the valve terminals remain on until the slide switch is placed in the OFF or REMOTE position.
2. With the slide switch in the REMOTE position, the system only operates if the remote receiver receives commands from the transmitter.
3. With the slide switch in the OFF position, the system is off. It is suggested that the slide switch be placed in the off position if you will be away from your home for an extended period of time. With the remote receiver located out of children's reach, placing the slide switch in the OFF position also functions as a safety "lock -out" by both turning the system off and rendering the transmitter inoperative. You may also engage the CHILD PROOF (CP) "LOCK OUT" at the transmitter. See section CHILD-PROOF "LOCKOUT" (CP) in later section of this manual.

WARNING

This remote control system must be installed exactly as outlined in these instructions. Read all instructions completely before attempting installation. Follow instructions carefully during installation. Any modifications of the SKYTECH remote control or any of its components will void the warrant and may be pose a fire hazard.

Do not connect any gas valve or electronic module directly to 110-120VAC power. Consult gas appliance manufacturer's instructions and wiring schematics for proper placement of all wires. All electronic modules are to be wired to manufacturer's specifications.

The preceding diagrams are for illustration purpose only. Follow instructions from manufacturer of gas valve and/or electronic module for correct wiring procedures. Improper installation of electric components can cause damage to electronic module, gas valve and remote receiver.

LOCATING RECEIVER AND OPERATING FUNCTIONS

The remote receiver can be positioned under the firebox in the control compartment of the fireplace if ambient temperatures do not exceed 120 Degrees F. The remote receiver accepts commands from the transmitter and is capable of remotely operating several separate circuit functions. This system is designed to control the following components:

	<u>WIRE COLORS</u>	
Gas Valve	(Red wires)	-Millivolt or electronic ignition
Fan/Blower	(Blue wires)	-110 VAC plug-in or in-line ON/OFF switch

NOTE: remote receiver will only respond to the transmitter when the 3-position slide button on the remote receiver is in the REMOTE position. If the system does not respond to the transmitter on initial use, see section, MATCHING SECURITY CODES.

WIRING INSTRUCTIONS

WIRING MILLIVOLT VALVES

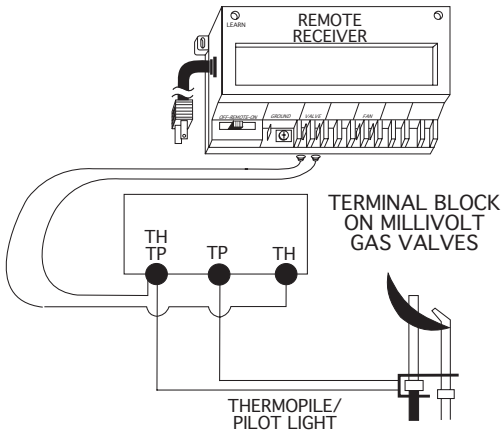

The terminal block on the receiver includes two 1/4" terminals marked VALVE. Using two, 18 ga. stranded wires (RED), with appropriate insulated connectors attached to each end, plug one end of each wire into one of the two terminals marked VALVE on the remote receiver, and connect the other ends of these wires to the (1) TH and (1) TH/TP terminals located on the gas valve. It does not matter which wires go to which set of terminals at the receiver or at the gas valve. This is a DRY CONTACT circuit and no power is provided to these terminals by the remote receiver.

NOTE: Some gas valves are polarized. If the remote receiver's ON/REMOTE/OFF functions don't operate the gas valve, reverse the receiver wires at the TH transmitter on the gas valve terminal block.

Operation of the remote receiver is similar to that of a thermostat in that both turn the gas valve on and off. A thermostat's input signals are from different temperatures. The remote receiver's input signals are sent from the transmitter, either manually or thermally.

WIRING ELECTRONIC SPARK IGNITION

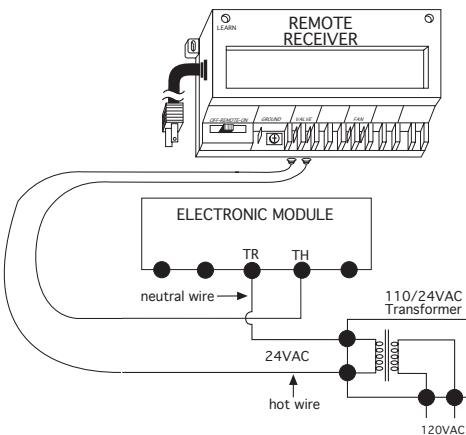

The remote receiver can be connected to a 24VAC transformer that operates an electronic ignition module, using the same VALVE terminals on the remote receiver to complete the 24 VAC circuit to the electronic ignition module.

Connect the neutral wire from the 24 VAC transformer to the TR (transformer) terminal on the ELECTRONIC IGNITION MODULE. Connect the hot wire from the 24 VAC transformer to either VALVE terminal on the remote receiver. Connect another same-gauge wire between the other VALVE terminal on the remote receiver to the TH (thermostat) terminal on the ELECTRONIC IGNITION MODULE.

METHOD #1

WIRING A FAN/BLOWER

NOTE: When connecting wires to the fan, make sure the 110VAC power to the fan has been turned off!

This SKYTECH receiver provides 2 separate methods to operate a fan/blower system that may be included with your heating appliance.

METHOD #1 PLUG FAN CORD DIRECTLY INTO REMOTE RECEIVER

On the backside of the receiver, the fan's 2-prong or 3-prong power cord can be plugged into the receiver's receptacle. This receptacle provides 110/120 – 5AMP power for a fan/blower.

METHOD #2 WIRE FAN LINE TO DRY CONTACT RECEIVER TERMINALS

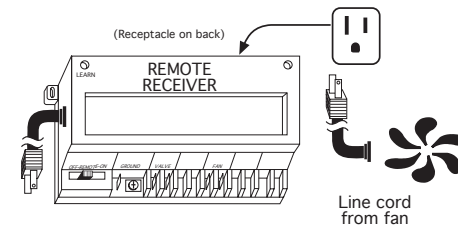
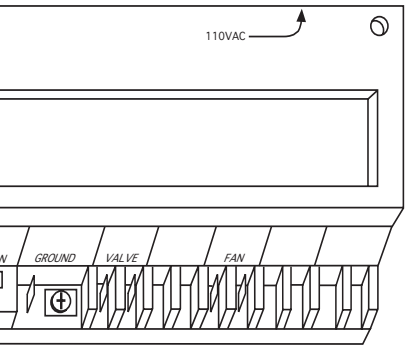

METHOD #2

For fan/blower systems that are “hard wired” directly to the appliance’s internal J-BOX, and use an in-line switch to control the fan/blower. The front of the receiver includes two 1/4” terminals that are controlled by a “DRY CONTACT” relay. These two terminals DO NOT provide any power to the fan/blower, they only complete a “dry contact” circuit between the “hot” leg leading to the fan/blower. These terminals are marked FAN.

CAUTION: DISCONNECT POWER TO FIREPLACE BEFORE MAKING THIS CONNECTION.

The SKYTECH receiver in this remote control system is designed to control the fan motor to either ON or OFF. It will not operate a 3-speed or variable controller other than to turn it OFF or ON at whatever position the switch or controller is set. If the fireplace system has a 3-speed or variable speed fan and you wish to remotely control it ON/OFF, attach two wires from the remote receiver to this switch. The speed selection switch will be operational, however, the receiver will only operate the fan/blower ON or OFF at the current setting of the speed controller.

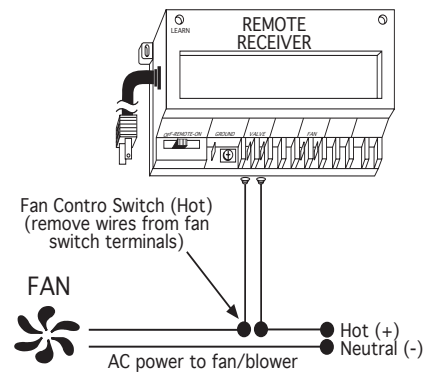

DRY CONTACT TERMINALS

There may be other sets of 1/4” terminals on the receiver, which may be available for controlling other “DRY CONTACT” functions. Refer to the SUPPLEMENTAL DRY CONTACT instruction sheet for operation of these “DRY CONTACT” TERMINALS.

GROUNDING THE RECEIVER

The terminal block on the receiver includes a 1/4” male terminal and a 1/4” screw that can be used to ground the fan/blower or appliance to the 110/120 VAC circuit powering the receiver. These connectors are marked GROUND. Using an 18 ga. Wire, usually GREEN in color, attach the grounding wire to the 1/4” terminal on the remote receiver. You may also attach the grounding wire under the grounding screw.

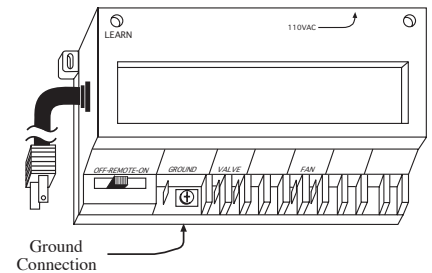

SYSTEM CHECK

MILLIVOLT VALVES

Light your gas appliance following the lighting instructions that came with the appliance. Confirm that the pilot flame is on; it must be in operation for the main gas valve to operate.

1. Slide the 3-position button on the remote receiver to the ON position. The main gas flame (i.e., the fire) should ignite.
2. Slide the button to OFF. The flame should extinguish (the pilot flame will remain on).
3. Slide the button to REMOTE (the center position), and then press the MODE button on the transmitter to change the system to ON. The main gas flame should ignite.
4. Press the MODE button on the transmitter to change the system to OFF. The flame should extinguish (the pilot flame will remain on).
5. Press the MODE button on the transmitter to change the system to THERMO. Advance the SET temperature on the transmitter to a temperature of at least 2 °F (1 °C) above the ROOM temperature displayed on the LCD screen. With this manual setting, the normal thermostatic cycle is overridden and the system flame will ignite. Set the SET temperature to at least 2 °F (1 °C) below the room temperature and the system flame will extinguish in a few seconds. Thereafter, it should continue to cycle to on and off thermostatically approximately every two minutes as the ROOM temperature changes, but only when the temperature differential between ROOM and SET temperatures differ at least 2 °F (1 °C). The 2 °F differential is the factory setting.

ELECTRONIC IGNITION SYSTEMS

1. Slide the 3-position button on the remote receiver to the ON position. The spark electrode should begin sparking to ignite the pilot (the pilot may ignite after only one spark). After the pilot flame is lit, the main gas valve should open and the main gas flame should ignite.
2. Slide the button to OFF. The main gas flame and pilot flame should BOTH extinguish.
3. Slide the button to REMOTE (the center position), and then press the MODE button on the transmitter to change the system to ON. The spark electrode should begin sparking to ignite the pilot. After the pilot is lit, the main gas valve should open and the main gas flame should ignite.
4. Press the MODE button on the transmitter to OFF. The main gas flame and pilot flame should BOTH extinguish.
5. Press the MODE button on the transmitter to change the system to THERMO. Advance the SET temperature on the transmitter to a temperature of at least 2 °F (1 °C) above the ROOM temperature displayed on the LCD screen. With this manual setting the normal thermostatic cycle is overridden and the system flame will ignite. Set the SET temperature to at least 2 °F (1 °C) below the room temperature and the system flame will extinguish in a few seconds. Thereafter, it should continue to cycle to on and off

thermostatically approximately every two minutes as the ROOM temperature changes, but only when the temperature differential between ROOM and SET temperatures differ at least 2 °F (1 °C). (The 2 °F differential is the factory setting).

TIMER

The countdown timer will operate in either the manual ON or THERMO mode. Once the fireplace system is in an operating mode, set the countdown timer to turn off in 15 minutes. The timer function will allow operation to continue until the countdown “time” on the LCD screen expires. After 15 minutes elapses, the system should turn OFF.

If you have any problems with operation, recheck your connections and ensure transmitter batteries are fully charged. If no problem is found, contact the dealer where you purchased your fireplace/remote control.

GENERAL INFORMATION

LEARNING TRANSMITTER TO RECEIVER

Each transmitter uses a unique security code. It will be necessary to press the LEARN button on the receiver to accept the transmitter security code upon initial use, if batteries are replaced, or if a replacement transmitter is purchased from your dealer or the factory. In order for the receiver to accept the transmitter security code, be sure the slide button on the receiver is in the REMOTE position; the receiver will **not** LEARN if the slide switch is in the ON or OFF position. The LEARN button is located on the front face of the receiver; inside the small hole labeled LEARN. Using a small screwdriver or end of a paperclip gently press and release the black LEARN button inside the hole. When you release the LEARN button the receiver will emit an audible “beep”. After the receiver emits the beep press the transmitter MODE button and release. The receiver will emit several beeps indicating that the transmitter’s code has been accepted into the receiver.

The microprocessor that controls the security code matching procedure is controlled by a timing function. If you are unsuccessful in matching the security code on the first attempt, wait 1-2 minutes before trying again – this delay allows the microprocessor to reset its timer circuitry – and try up to two or three more times.

CHILD-PROOF “LOCK –OUT” –(CP)

This SKYTECH remote control includes a CHILD-PROOF “LOCK-OUT” feature that allows the user to ‘LOCK –OUT” operation of the fireplace, from the TRANSMITTER.

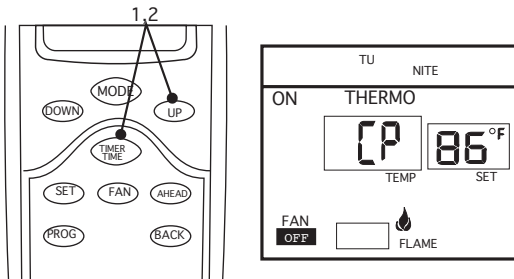

SETTING “LOCK-OUT” – (CP)

1. To activate the “LOCK-OUT” feature, press and hold the **UP** and **TIMER/TIME** buttons, together, for 5 seconds. The letters **CP** will appear in the **TEMP** frame on the LCD screen.
2. To disengage the “LOCK-OUT”, press and hold the **UP** and **TIMER** buttons, together for 5 seconds or more, and the letters **CP** will disappear from the LCD screen and the transmitter will return to its normal operating condition.

NOTE: If the fireplace system is already operating in the ON, THERMO or PROGRAM MODES, engaging the “LOCK-OUT” will not cancel the operating MODE. Engaging the “LOCK-OUT” prevents only the manual operation of the TRANSMITTER. If in the auto modes, the THERMO and/or PROGRAM operation will continue to operate normally. To totally “LOCK-OUT” the operation of the TRANSMITTER’S operating signals, the transmitter’s MODE must be set to OFF.

THERMO FUNCTION

When the transmitter is in the THERMO mode, it should be kept away from direct sources of heat such as fireplaces, incandescent lighting, and direct sunlight. Leaving the transmitter in direct sunlight, for example, will cause its heat-sensing diode to read the room temperature higher than it actually is; if in THERMO mode, it may not turn on the appliance even if the ambient ROOM temperature is below the SET temperature.

BATTERY LIFE

Life expectancy of alkaline batteries in the SKYTECH 3301PF should be at least 12 months. Replace all batteries annually. When the Transmitter no longer operates the receiver from a distance it did previously (i.e., the transmitter’s range has decreased) or the remote receiver does not function at all, the batteries should be checked. The length of the wire between the remote receiver and the gas valve

directly affects the operating performance of the remote system. The Transmitter should operate with as little as 2.5 volts battery power measuring at the (2) 1.5-volt batteries.

TROUBLE SHOOTING

Should you encounter problems with your fireplace system, the problem may be with the fireplace itself or it could be with the SKYTECH remote control. Review the fireplace manufacturer's operation manual to make sure all connections are properly made. Then check the operation of the SKYTECH remote in the following manner:

1. Check the receptacle supplying power to the REMOTE RECEIVER. The output should be 110-120 VAC. If there is no power to receptacle, check fuse or circuit breaker at main electrical panel. **NOTE: Be sure receptacle is not controlled by a wall switch.**
2. Be sure the transmitter's batteries are properly installed and that the battery output is 2.5 V or more.
3. Check to make sure the transmitter is communicating with the receiver.
 - If the receiver beeps when the MODE button is depressed on the transmitter they are communicating.
 - If the receiver does not beep when the MODE button is depressed on the transmitter, you will need to teach the receiver the code of the transmitter. This is done by holding the LEARN button down on the receiver, and at the same time depress the MODE button on the transmitter. A change in the beeping pattern, at the receiver indicates the transmitter's code has been programmed into the receiver.
4. Make sure the transmitter is within the 15 to 20-foot range of the receiver.
5. Positioning of the receiver is important. If the receiver is "enclosed" in a metal surround, the operation of the receiver may be affected as noted below. Reposition the receiver to improve operating range. It is suggested that a heat shield be installed to protect the receiver from extreme heat. If the receiver is "enclosed" in a metal surround, this can:
 - Cause the RF signal to get lost and not communicate with the receiver.
 - Cause the working distance to be shorter than normal.

NOTE: Areas that exceed 130 °F will cause the THERMO-SAFETY feature to cut in, requiring you to reposition the receiver to stop the warning beeps, and to "reset" the receiver's operation.

SPECIFICATIONS

BATTERIES: Transmitter 3V- 2 ea. AAA 1.5V, Alkaline

Remote Receiver 110 VAC, 60 Cycle

Operating Frequency: 303.8MHZ

FCC ID No.'s: transmitter –K9L3301TX; receiver – K9L3001RX

Canadian IC ID No.'s: transmitter – 2439-3301TX; receiver – 2439 102 760A

FCC REQUIREMENTS

NOTE: THE MANUFACTURER IS NOT RESPONSIBLE FOR ANY RADIO OR TV INTERFERENCE CAUSED BY UNAUTHORIZED MODIFICATIONS TO THIS EQUIPMENT. SUCH MODIFICATIONS COULD VOID THE USER'S AUTHORITY TO OPERATE THE EQUIPMENT.

FOR TECHNICAL U.S. INQUIRIES
SERVICE, CALL: 888/672-8929 or (260) 459-1703
Website: skytechsystems.com

CANADIAN INQUIRIES
877/472-3923

MANUFACTURED EXCLUSIVELY FOR SKYTECH II, IN

QUICK SET-UP GUIDE FOR SKYTECH 3301PF PROGRAMMABLE TRANSMITTER

This guide is a “short cut” method to SET – UP and OPERATE the SKYTECH programmable transmitter. For detailed instructions for each feature and function, see OWNE\$R’S MANUAL.

INITIAL SET-UP

SET FUNCTIONS USING BUTTONS ON FRONT OF TRANSMITTER

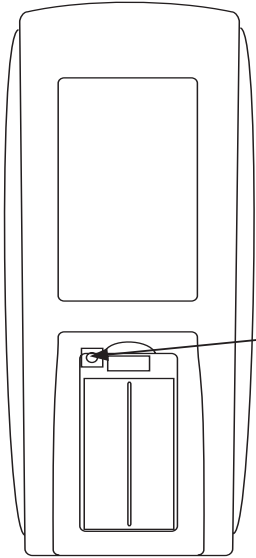

Setting Button

1. Remove battery cover.
2. Insert 2AAA batteries.
3. Press SETTING button.
4. Replace battery cover.

All further programming is to be made on front of transmitter.

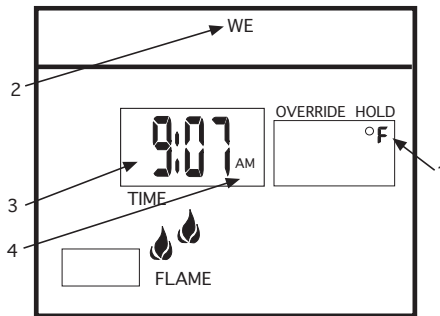

1. SCALE (^o F/ ^o C) – Press UP or DOWN button. Press SET button.
2. DAY OF WEEK – Press AHEAD or BACK button. Press SET button.
3. HOUR OF DAY – Press UP or DOWN button. Press SET button.
NOTE: AM or PM on LCD.
4. MIN. OF DAY – Press UP or DOWN button. Press SET button.

NOTE: Each SETTING will flash, separately, on LCD screen. After each SETTING you must push SET button. You may not have to change factory setting, but you must push SET button.

OPERATION – Press MODE button on TRANSMITTER to change operating functions.

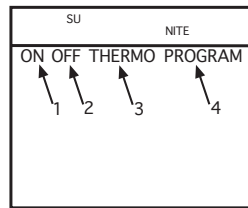
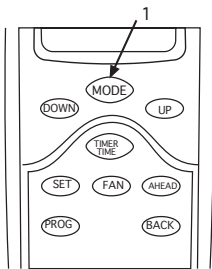

1. ON indicates the system is on, either manually or thermostatically.
2. OFF indicates the entire system is turned off.
3. THERMO indicates the system will automatically cycle ON/OFF, depending on programmed SET temperature.
4. PROGRAM indicates the system is operating with PROGRAMED settings.

OTHER OPERATIONS – Press corresponding buttons on TRANSMITTER to activate functions.

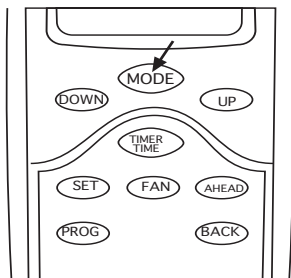

1. TIME OF DAY – Press TIMER/TIME button for less than ONE second.
2. TIMER OPERATION – Press and hold TIMER/TIME button for two seconds.
3. SET COUNTDOWN TIMER by pressing UP or DOWN buttons.
4. FAN OPERATION – Press FAN button.
NOTE: Press SET button to stop LCD Digits from flashing.

QUICK PROGRAMMABLE GUIDE FOR SKYTECH 3301PF PROGRAMMABLE TRANSMITTER

This guide is a “short cut” method to PROGRAM the operation of the SKYTECH programmable transmitter. For detailed instructions for each feature and function, see OWNER’S MANUAL.

PROGRAMMING DAILY OPERATION

NOTE: A FACTORY PROGRAM is already installed in the transmitter’s software.

You may change the daily “SET TIMES” and “SET TEMPERATURES” by following the instructions below.

DAY	PERIOD	TIME/TEMP
All 7 Days	MORN	6:00 AM 70°
Factory- Programmed	DAY	8:30 AM 60°
	EVE	3:00 PM 70°
	NIGHT	11:00 PM 63°

SHORT CUT PROGRAMMING

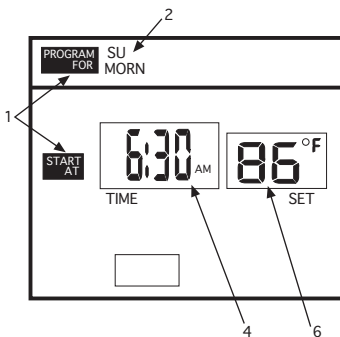
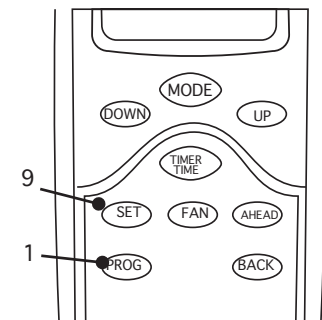

1. Press PROG button for more than 4 seconds. The PROGRAM FOR an START AT boxes on the LCD will begin blinking.
2. Program DAY OF WEEK and PERIOD OF DAY by pressing AHEAD and BACK buttons.
3. Again, press PROG button. START TIME will begin flashing.
4. Program START TIME by pressing UP or DOWN button.
5. Again, press PROG button. SET TIME will begin to flash.
6. Program SET TEMP by pressing UP or DOWN button.
7. Again, press PROG button. The next PERIOD and DAY will begin to flash.
8. Repeat steps 2 through 7 for all 7 DAYS until each PERIOD OF DAY is programmed.
9. When all programmed settings are complete, then press the SET to lock in new programming.
10. To REVIEW, either FACTORY or USER programs, push the PROG button for ONE SECOND; then scroll through each DAY and PERIOD OF DAY by pressing PROG button, allowing ONE SECOND between each press of this button. Press the SET button when through reviewing the programmed times and temperatures.
11. To CANCEL user-customized programming, press and hold PROG and SET buttons together, for 10 seconds; all USER programs will be cancelled and the FACTORY program will return

NOTE: Push AHEAD or BACK buttons to advance day and period should you not want to change each SET time or SET temperature.

Limited Lifetime Warranty

SKYTECH II warrants the SKYTECH REMOTE CONTROL SYSTEM for a Limited Lifetime of the original owner of this system. This warranty is not transferable to another person it is for the original purchaser of the product. Should any part fail because of defective workmanship or material from the original date of purchase. SKYTECH II will repair or, at SKYTECH II option, replace the defective parts.

Replacement parts will be available at no charge for the first (5) five years of this warranty, and will be available at market cost for the Lifetime of the product to that original owner. If SKYTECH II does not have the parts for an individual model, then a replacement SYSTEM will be provided. At no charge for the first (5) five years and sold at market cost for the Lifetime of that product to the original owner.

The Owner must provide a bill of sale, cancelled check, or payment record should be kept to verify purchase date and establish warranty period. Travel, diagnostic cost, service labor to repair the defective SYSTEM, and freight charges on warranty parts to and from the factory will be the responsibility of the owner. SKYTECH will not be responsible for labor charges and/or damage incurred in installation, repair, replacement, or for incidental or consequential damages. Batteries and any damage caused by them are not covered by them are not covered by this warranty.

This warranty does not cover claims, which do not involve defective workmanship or materials.

Damage to the SYSTEM caused by accident, misuse, abuse, or installation error, whether performed by a contractor, Service Company, or owner, is not covered by this warranty. Modification of the SKYTECH product will void this warranty.

IN NO EVENT SHALL SKYTECH BE LIABLE FOR INCIDENTAL AND CONSEQUENTIAL INCLUDING THE IMPLIED WARRANTIES OF MERCHANTABILITY AND FITNESS, ARE LIMITED TO THE DURATION OF THIS WRITTEN WARRANTY. THIS WARRANTY SUPERSEDES ALL OTHER ORAL OR WRITTEN WARRANTIES.

Some States do not allow the exclusion or limitation of incidental and consequential damages or limitation on how long an implied warranty lasts, so the above limitation may not apply to you. This warranty gives you specific rights and you may have other rights, which vary from state, province, and nation.

How to Obtain Service:

Contact SKYTECH II or your SKYTECH Dealer direct with the following information:

- Name, Address, Telephone Number of Owner
- Date of Purchase, Proof of Purchase
- Model Name, Date Code

Any relevant information or circumstances, e.g., installation, mode of operation when defect was noted.

Warranty claim process will start with all of this information. SKYTECH will reserve the right to physically inspect the product for defects, by authorized representatives.

Detach at this line for return to: Skytech II 9230 Conservation Way, Fort Wayne, IN 46809 Telephone: (888) 672-8929

Purchase Date: _____ Model: _____ Date Code: _____

Purchased From: _____ Date: _____

Customer Name _____ Number of Santa's Helpers _____

Address _____

City _____ State/Prov. _____ Zip/Postal Code _____

Credit Card Number _____ Expiring Date _____
(Visa and MasterCard Only) See other side for a special offer for all Remote control Customers

Santa's Helper

Exclusive offer to Skytech Remote Control Owners

This special offer is only provided to customers of Skytech II, Inc. that have purchased a remote control for their Hearth Product. This remote control system can be used for any 110Volt appliance, but perfect your Christmas Tree Lights or any other appliance that is difficult to reach or plug in. Simply plug the receiver into your wall outlet and your appliance into the receiver, push the ON button on the transmitter and you are in business. It's that easy.

Model **1310** \$29.95



Santa's Helper

Santa's Helper is a unique and specialized device designed to save time and effort. Every Christmas brings the challenge of plugging in the lights on the tree. But this year can be different. Simply plug the remote directly into a standard 110 household electrical outlet and plug your light directly into the receiver. You can even use an extension cord for convenience. Then with a

simple push of the button on the transmitter, your lights are turned on and off with ease.

From as far away as 100 feet, the radio frequency controls only what is plugged into the receiver. With over 255 security codes, no other appliances will be affected. And best of all, you don't even have to point the remote at the receiver.

Features:

- 110 VAC - input
- 2 prong polarized plug
- 110 VAC - output
- 2 prong polarized receptacle
- 1000 Watts of rated power or 1/4 HP motor
- Transmitter is battery operated (12 Volt included)
- 255 Security Code
- 100 feet of Operational Distance
- All Radio Frequency
- UL and FCC Approved

  888-672-8929 | 888-672-8024 (FAX)
9230 CONSERVATION WAY | FORT WAYNE, INDIANA 46809

The list price of **\$29.95** for the Santa's Helper has been cut almost in half to **\$15.00 USD** for this exclusive offer. Shipping and handling of **\$5.00 USD** should be added. Send your check, money order or your Visa / MasterCard number, with Expiration Date to our office, along with the warranty information from your remote control for your Hearth Product. You can send this via mail, fax, or e-mail.

Skytech II, Inc.

9230 Conservation Way
Fort Wayne, IN 46809

1 (888) 672-8929

1 (888) 672-8024 Fax

support@skytechsystem.com e-mail